

'Apollo' Valves

SUBMITTAL SHEET

70-100 Series

Standard Port Threaded Ball Valve



Job Name:	
Job Location:	
Engineer:	
Contractor:	
Tag:	
PO Number:	
Representative:	
Wholesale Distributor:	



DESCRIPTION

The Apollo® 70 Series is the most widely used general purpose bronze ball valve on the market today. The 70-100 model is a 2-piece standard port* ball valve featuring female NPT connections. Cast and machined in Apollo's South Carolina manufacturing plants, these valves provide trusted performance and a wide range of options.

FEATURES

- Premium Materials and Heavy Duty Construction
- Adjustable Stem Packing Gland
- Blow-Out Proof Stem Design
- RPTFE Seats and MPTFE Stem Packing Rings
- Chromium Plated Ball
- 100% Factory Tested
- Wide Range of Options (See Page 2)
- **Manufactured in the USA – ARRA Compliant**

MODELS

- 70-100 Series Standard
- 70-140 Series 316 SS Ball & Stem
- 70-190 Series Pinned Retainer
- 70LF Series Lead Free Option
(Refer to 70LF submittal sheet for specifications)

APPROVALS

- MSS SP-110; Ball Valves Threaded, Socket-Welding, Solder Joint, Grooved and Flared Ends
- CSA B51 CRN: OC10908.5C

STANDARD MATERIALS LIST

Part Name	Material
Lever and Grip	Steel, Zinc Plated w/ Vinyl
Stem Packing	MPTFE
Stem Bearing	RPTFE
Ball	B16, Chrome Plated or B283, C37700
Seat (2)	RPTFE
Retainer	B16 or B283, C37700 (1/4" to 1"), B584-C84400 (1 1/4" to 4")
Gland Nut	B16
Stem	B16
Lever Nut	Steel, Zinc Plated
Body Seal (1 1/4" to 4")	PTFE
Body	B584-C84400

PERFORMANCE RATING

- Maximum Pressure: 600 psi CWP, 150 psi SWP
- Maximum Temperature: 500°F
- Vacuum Service to 29 in. Hg

DIMENSIONS

Part Number	Size (in.)	Dimensions (in.)					Wt. (lbs.)
		A	B	C	D	E	
70-101-01	1/4"	0.37	1.03	2.06	1.75	3.87	0.60
70-102-01	3/8"	0.37	1.03	2.06	1.75	3.87	0.56
70-103-01	1/2"	0.50	1.12	2.17	1.75	3.87	0.63
70-104-01	3/4"	0.68	1.50	3.00	2.12	4.87	1.39
70-105-01	1"	0.87	1.68	3.37	2.25	4.87	1.72
70-106-01	1-1/4"	1.00	2.00	4.00	2.62	5.50	3.26
70-107-01	1-1/2"	1.25	2.18	4.37	3.06	8.00	4.61
70-108-01	2"	1.50	2.34	4.68	3.25	8.00	6.06
70-109-01A	2-1/2"	2.00	3.12	6.25	3.72	8.00	17.25
70-100-01	3"	2.50	3.37	6.75	4.12	8.00	18.60
70-10A-01	4"	3.12	3.68	7.37	5.25	10.00	25.50

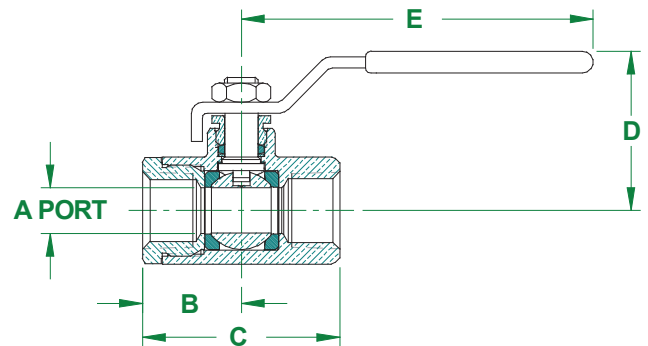

Apollo Valves, Manufactured by **Conbraco Industries, Inc.**
 701 Matthews Mint-Hill Road, Matthews, NC 28105 USA
www.apollovalves.com | (704) 841-6000

This specification is provided for reference only. Conbraco Industries Inc. reserves the right to change any portion of this specification without notice and without incurring obligation to make such changes to Conbraco products previously or subsequently sold. Please visit our website @ www.apollovalves.com for the most current information.



"Apollo" Valves

SUBMITTAL SHEET

70-100 Series

Standard Port Threaded **Ball Valve**

OPTIONS & SIZES

• (-02) Stem Grounded	1/4" - 4"
• (-04) 2 1/4" CS Stem Extension	1/4" - 3"
• (-05) Plain Ball	1/4" - 3"
• (-07) Steel Tee Handle	1/4" - 2"
• (-08) 90° Reversed Stem	1/4" - 3"
• (-10) SS Lever & Nut	1/4" - 3"
• (-11) Therma-Seal™ Insulating Tee Handle	1/4" - 2"
• (-14) Side Vented Ball (Uni-Directional)	1/4" - 4"
• (-15) Wheel Handle, Steel	1/4" - 2"
• (-16) Chain Lever-Vertical	3/4" - 2"
• (-21) UHMWPE Trim (Non-PTFE)	1/4" - 3"
• (-24) Graphite Packing	1/4" - 3"
• (-27) SS Latch-Lck Lever & Nut	1/4" - 3"
• (-30) Cam-Lock & Grounded	1/4" - 2"
• (-32) SS Tee Handle & Nut	1/4" - 2"
• (-35) VTFE Trim	1/4" - 3"
• (-36) SS Hi-Rise Round Handle, SS Nut	1/4" - 2"
• (-39) SS Hi-Rise Locking Wheel Handle & Nut	1/4" - 2"
• (-40) Cyl-Loc & Grounded	1/4" - 2"
• (-41) Automatic Drain (Bronze Valves Only)	1/4" - 2"
• (-45) Less Lever & Nut	1/4" - 3"
• (-46) Latch Lck Lever-Lck Closed Position Only	1/4" - 3"
• (-47) SS Oval Latch-Lock Handle & Nut	1/4" - 1"
• (-48) SS Oval Handle (No Latch) & Nut	1/4" - 2"
• (-49) Assembled Dry	1/4" - 4"
• (-50) 2-1/4" CS Locking Stem Extension	1/4" - 3"
• (-56) MPTFE Seats and Packing	1/4" - 3"
• (-57) Oxygen Cleaned	1/4" - 4"
• (-58) Chain Lever-Horizontal	3/4" - 2"
• (-60) Static Grounded Ball & Stem	1/4" - 3"
• (-63) NPT x Solder	3/8" - 4"
• (-64) 250# Steam Trim	1/4" - 3"
• (-92) Balancing Stop	1/4" - 3"
• (-94) 2-1/4" Stem Extension & Balancing Stop	3/8" - 3"
• (-HC) Hose Thread w./ Cap & Chain	1/2" - 1"
• (-P01) BSPP (Parallel) Thread Connection	1/4" - 3"
• (-T01) BSPT (Tapered) Thread Connection	1/4" - 3"
• (-BC) Integral Check Cartridge (250psi max)	1/2" - 2"

Apollo Valves, Manufactured by **Conbraco Industries, Inc.**
 701 Matthews Mint-Hill Road, Matthews, NC 28105 USA
www.apollovalves.com | (704) 841-6000

This specification is provided for reference only. Conbraco Industries Inc. reserves the right to change any portion of this specification without notice and without incurring obligation to make such changes to Conbraco products previously or subsequently sold. Please visit our website @ www.apollovalves.com for the most current information.

