



## BROADBAND DISTRIBUTED AMPLIFIER

## ADM1-0026PA

The ADM1-0026PA is a complete LO driver solution for use with all Marki mixers up to 26.5 GHz. This single-stage packaged GaAs MMIC distributed amplifier integrates all required biasing circuitry. It offers 12 dB typical gain and 21 dBm saturated output power, which is suitable for driving all L, M, I, and H mixers. In saturation it produces a square wave that is optimal for driving a T3 with the highest linearity. The amplifier is operated with a +3V to +7 V positive bias and an optional current reducing negative voltage. While optimized as a mixer LO driver, it is suitable for many applications in test and measurement and laboratory applications.

### Features

- Broadband 50  $\Omega$  Matching
- Unconditionally Stable
- Optimized for use as a [T3 LO buffer amplifier](#)
- Suitable for driving L, M, I, and H diode mixers
- Optional Positive Only Bias Operation
- Integrated Blocking Capacitors and Inductors
- 3<sup>rd</sup> and 5<sup>th</sup> Harmonic Generation

**Electrical Specifications** - Specifications guaranteed from -55 to +85°C, measured in a 50-Ohm system.

Parameter	Frequency (GHz)	Min	Typ	Max	
Input for Saturated Output (dBm)	.005-26.5	+5	+10	+15	
Output 1 dB Compression (dBm)			+17		
Saturated Output Power with negative bias (dBm)				+20	
Small Signal Gain (dB)				12	
Input Return Loss (dB)				13	
Output Return Loss (dB)				17	
Noise Figure (dB)				4	
Third Order Output Intercept Point (dBm)				+ 25	
Bias Requirements (mA)					
Vd: +3.0 to +7.0 / Vg: -0.2 to -0.3 Volts			165	250	
Vd: +3.0 to +7.0 / Vg: 0 Volts			250	280	

### Part Number Options

Model Number	Description	Green Status
ADM1-0026PA <sup>1</sup>	5 MHz to 26.5 GHz Amplifier	RoHS

<sup>1</sup> Note: For port locations and I/O designations, refer to the drawings on page 6 of this document.

***GaAs MMIC devices are susceptible to Electrostatic Discharge. Use proper ESD precautions when handling these items.***

**BROADBAND DISTRIBUTED AMPLIFIER**

**ADM1-0026PA**

Page 2

Frequency 5 MHz to 26.5 GHz

Typical Performance – Positive Bias Only

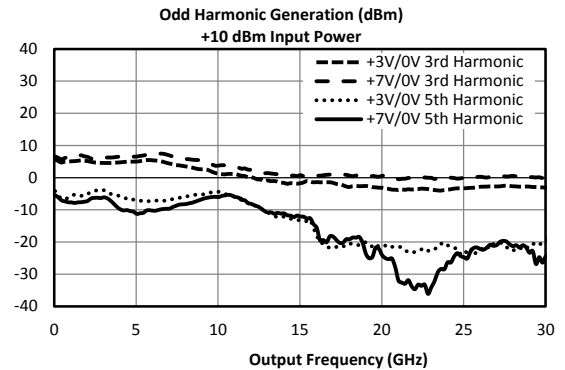
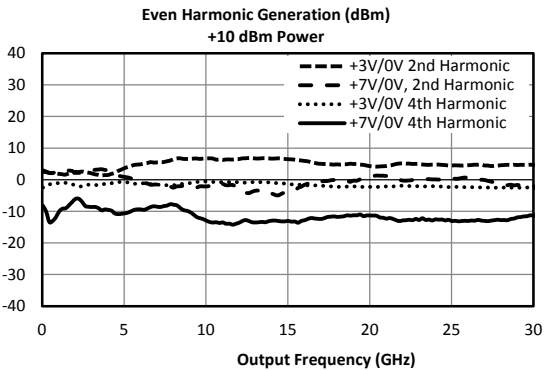
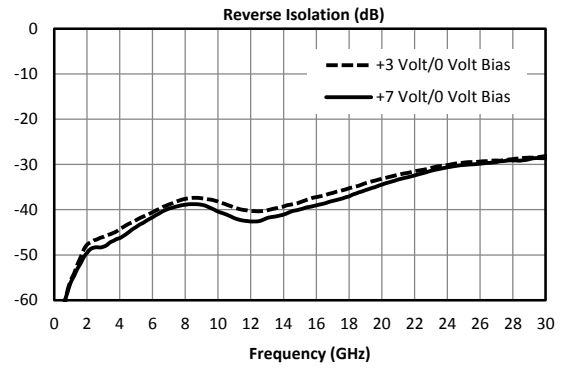
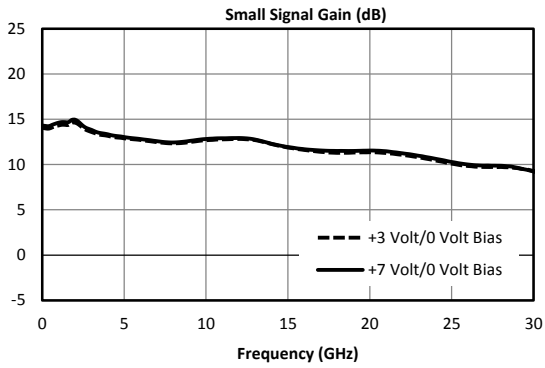
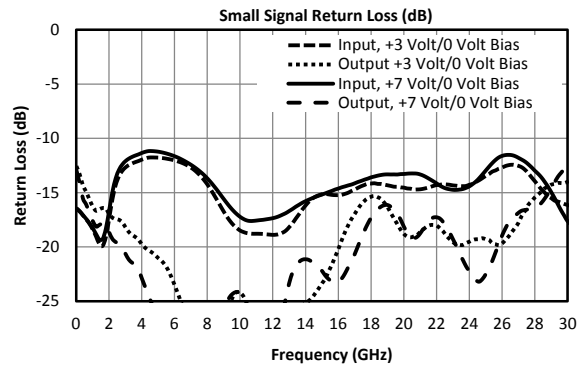
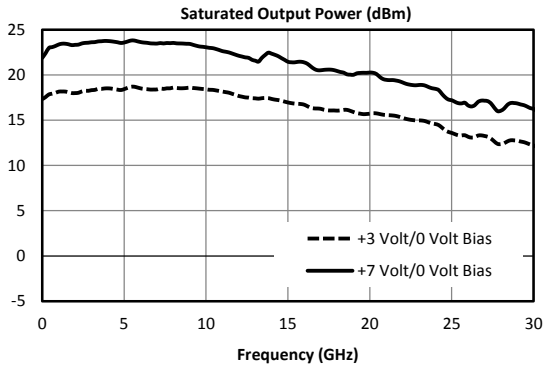

# BROADBAND DISTRIBUTED AMPLIFIER

# ADM1-0026PA

Page 3

Frequency 5 MHz to 26.5 GHz

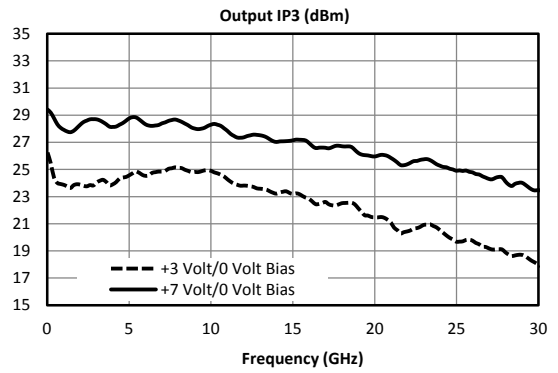
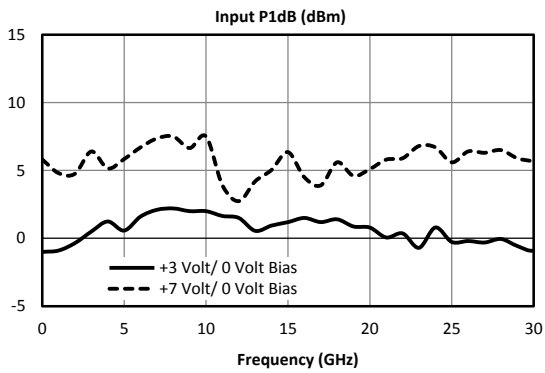
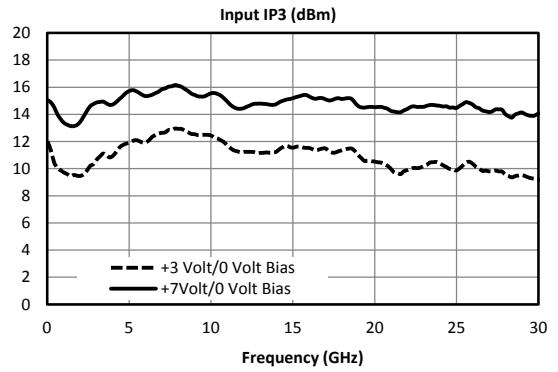
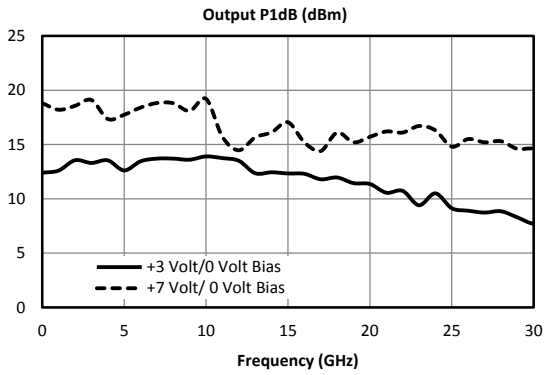

## Typical Performance – Positive and Negative Bias

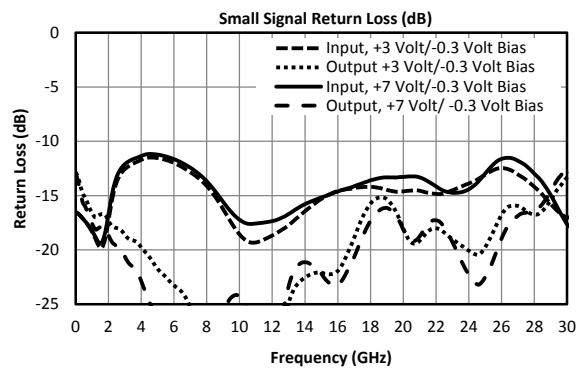
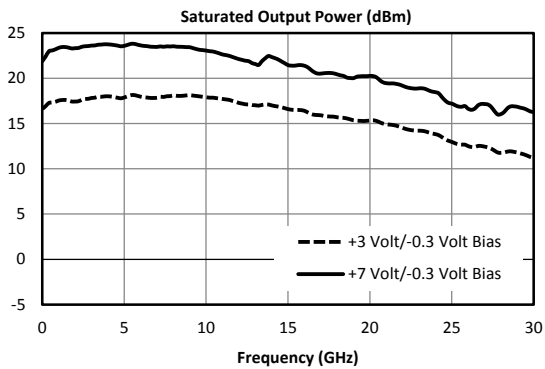

# BROADBAND DISTRIBUTED AMPLIFIER

# ADM1-0026PA

Page 4

Frequency 5 MHz to 26.5 GHz

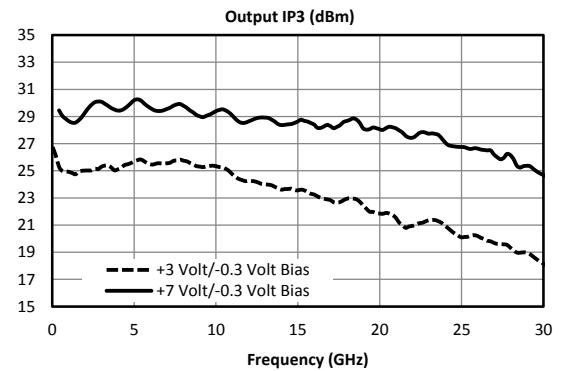
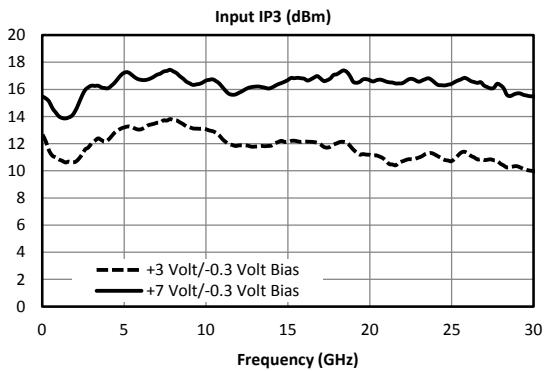
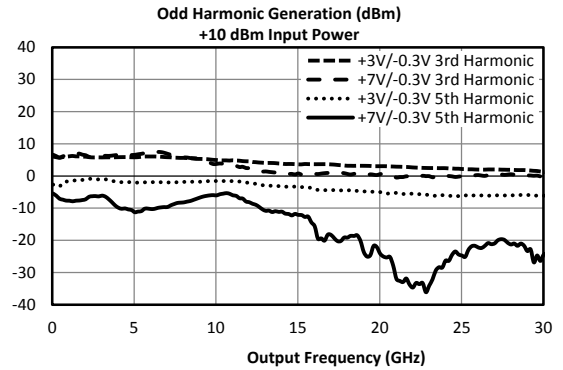
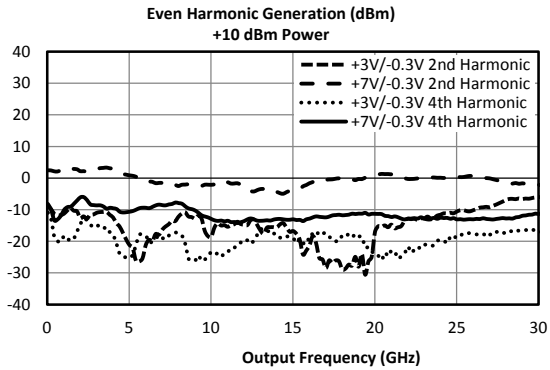
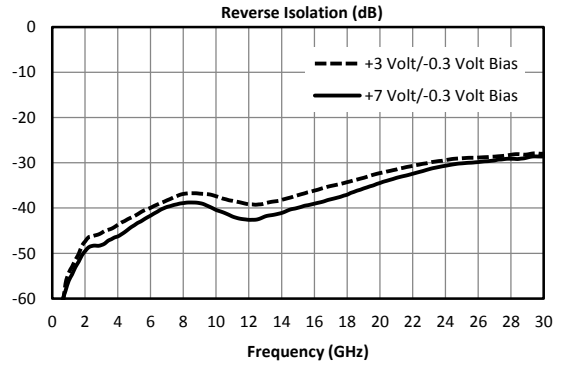
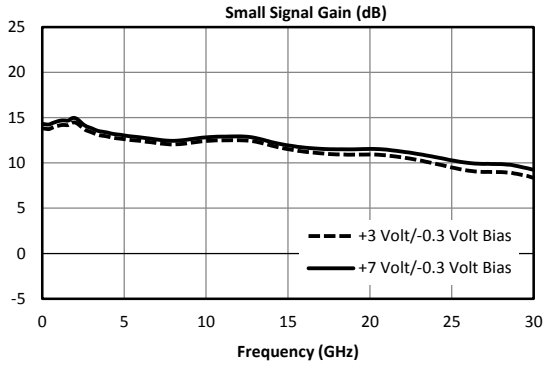



# BROADBAND DISTRIBUTED AMPLIFIER

# ADM1-0026PA

Page 5

Frequency 5 MHz to 26.5 GHz

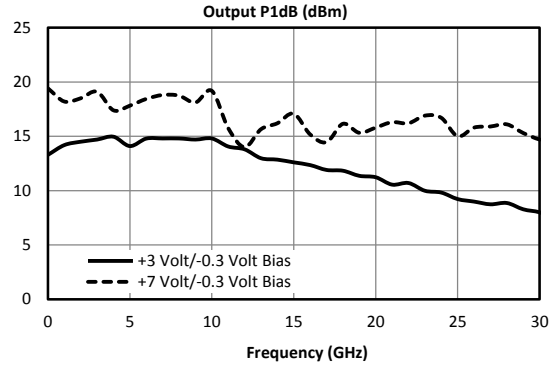
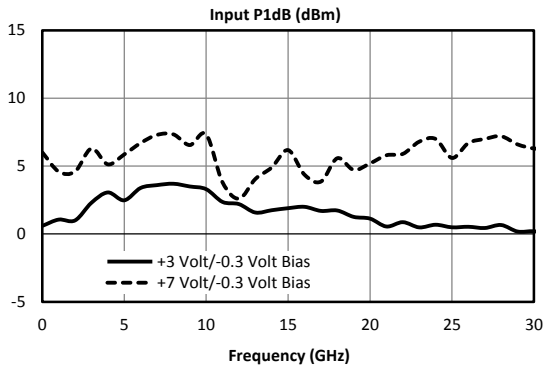

## Typical Performance – All Bias

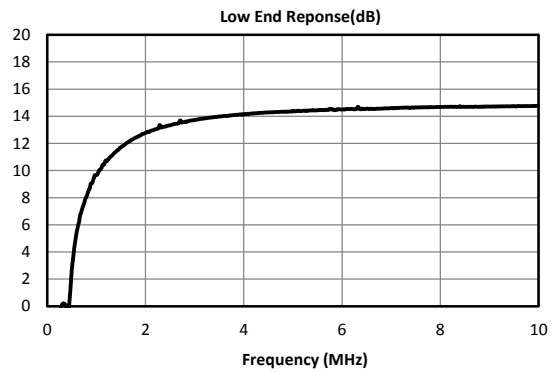
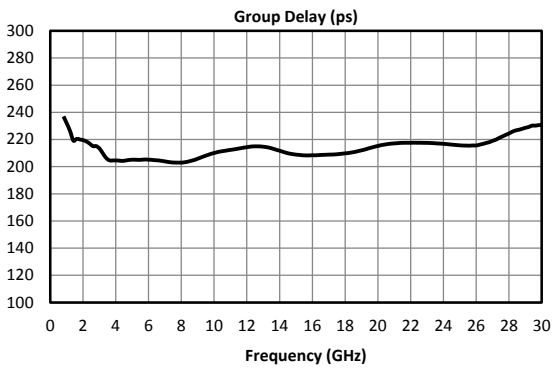
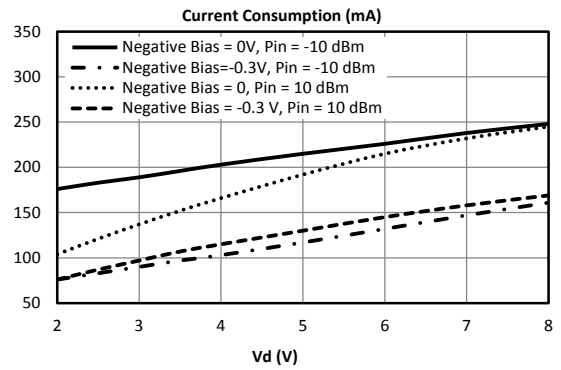
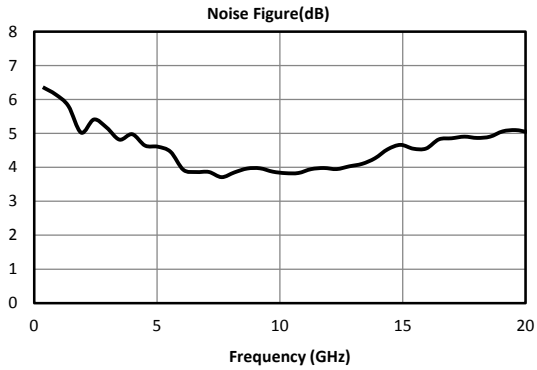

**BROADBAND DISTRIBUTED AMPLIFIER**

**ADM1-0026PA**

Page 6

Frequency 5 MHz to 26.5 GHz

Outline Drawing

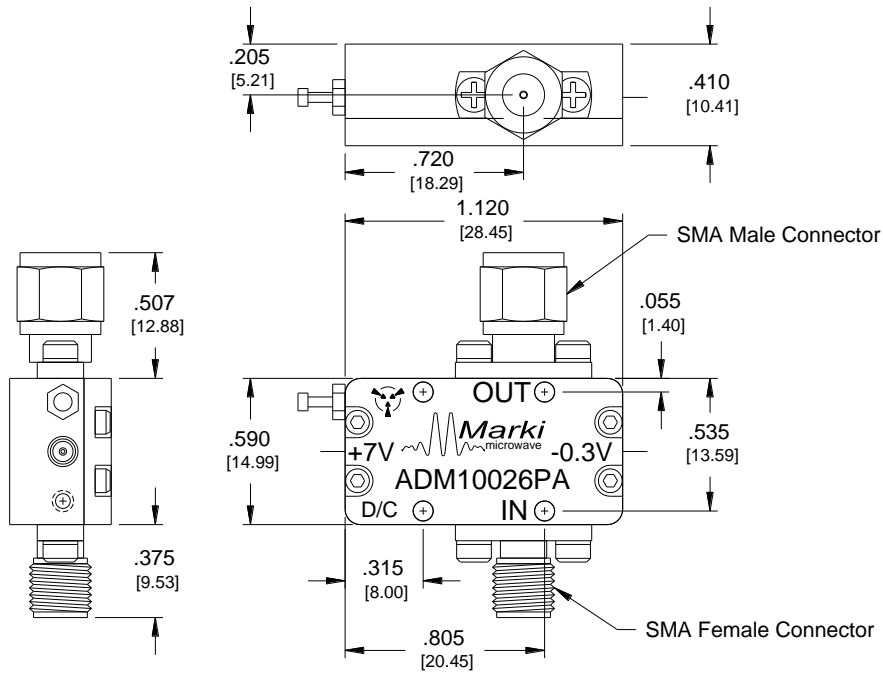

Absolute Maximum Ratings	
Parameter	Maximum Rating
Positive Bias Voltage	9 V
Positive Bias Current	280 mA
Negative Bias Voltage	-2 V
Negative Bias Current	0.5 mA
RF Input Power	+15 dBm
Power Dissipation	2.25 W
ESD (Human Body Model)	Class 0
Operating Temperature	-55°C to +85°C
Storage Temperature	-65°C to +150°C

# BROADBAND DISTRIBUTED AMPLIFIER

# ADM1-0026PA

Page 7

Frequency 5 MHz to 26.5 GHz

### Application Information

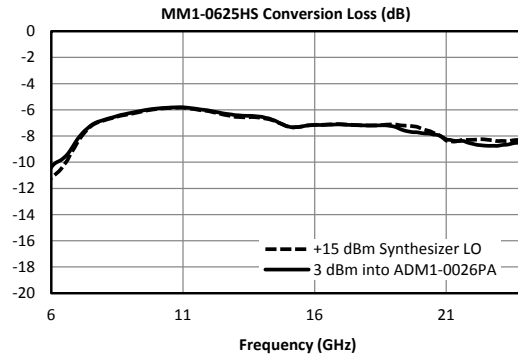
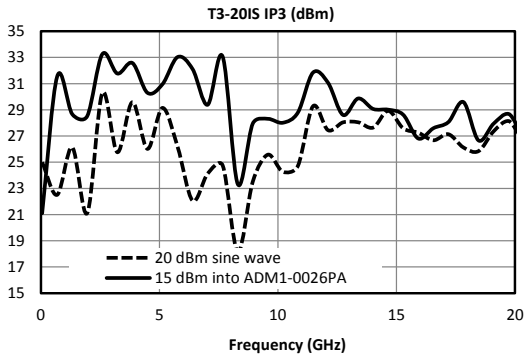
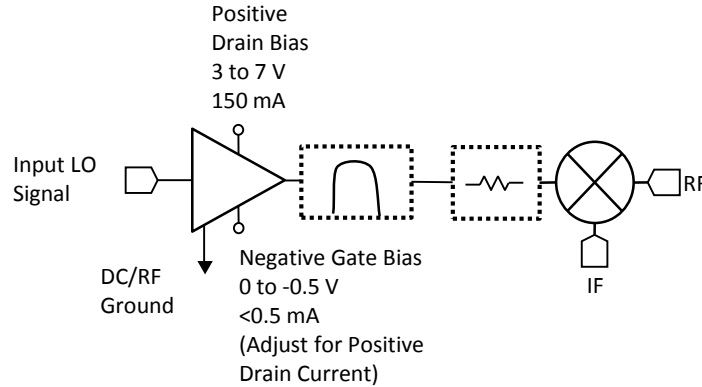

Applications Information		
Application	Input Power	Comments
T3 LO Driver	+10 to +15 dBm	Ideal choice for driving all T3 mixers down to 10 MHz. When driven beyond the 1 dB compression point (with inputs higher than 10 dBm), it will create a saturated square wave output that improves the IP3, spurious suppression, and 1 dB compression of the T3 mixer, especially at lower frequencies.
Broadband Mixer LO Driver	-5 to +10 dBm	Can be used to drive any double balanced mixer with an H diode or lower (including L, I, and M diodes). For this purpose saturated operation is not preferred, and may cause undesirable results. Input power should be kept in the -5 to +10 dBm range to provide appropriate output power, depending on the mixer.
General Purpose Linear RF Amplifier	<+5 dBm	Can be used as a general purpose amplifier for RF signals. Input power should be kept below +5 dBm for linear operation.



## BROADBAND DISTRIBUTED AMPLIFIER

**ADM1-0026PA**

Page 8

Frequency 5 MHz to 26.5 GHz

### Biassing and Operation

**Positive Bias (Vd)** – Bias supply on Vd should be voltage limited below 9 V and current limited below 250 mA at all times. The operational bias voltage should be between 3 V and 7 V for full gain, efficiency, and linearity. In general linearity and output power will increase marginally with increased voltage from 3 to 7 V.

**DC/RF Ground** – The ground lug or case should be attached to the DC power supply ground at all times.

**Negative Bias (Vg)**– Bias on these pins is recommended. Application of a negative bias can reduce the current draw from the positive supply, slightly improve small signal gain at higher frequencies, significantly improve even order harmonic suppression, and improve nonlinear performance of a T3 mixer. Due to the reduced current, it may also extend the lifetime of the amplifier. The amplifier is designed to perform optimally when the negative bias voltage is adjusted so that the amplifier draws 150 mA on the *positive* supply.

**Heat Sinking** – Heat sinking is recommended to extend the lifetime of the amplifier whenever the amplifier will be operational for extended periods of time, particularly at elevated temperatures or when the negative bias is grounded.

#### DATA SHEET NOTES:

1. Specifications are subject to change without notice. Contact Marki Microwave for the most recent specifications and data sheets.

*Marki Microwave reserves the right to make changes to the product(s) or information contained herein without notice. Marki Microwave makes no warranty, representation or guarantee regarding the suitability of its products for any particular purpose, nor does Marki Microwave assume any liability whatsoever arising out of the use of or application of any product.*