

# Mini-SUMO PUMP

## User Operating and Maintenance Manual

Original text translation

### CONTENT

---

1. INTRODUCTION
2. GENERAL DESCRIPTION
3. IDENTIFICATION OF THE MACHINE
4. TECHNICAL FEATURES
5. MACHINE COMPONENTS
6. UNPACKING AND INSTALLATION
7. INSTRUCTIONS FOR USE
8. PROBLEMS AND SOLUTIONS
9. MAINTENANCE PROCEDURES
10. DISPOSAL
11. ORDER INFORMATION
12. DIMENSIONS
13. HANDLING AND TRANSPORT
14. PRECAUTIONS FOR USE
15. OPERATIONAL HAZARDS



The manual has been prepared in compliance with Directive  
CE 06/42

C2158IE WK 03/17

## 1. INTRODUCTION

This user and maintenance manual relates to the **Mini-SUMO pump**.

The latest version may be obtained from the Technical-Commercial Office, or by consulting our web site <http://www.dropsa.com>.

The pump subject of this manual must be used by qualified personnel with basic hydraulic and electrical knowledge.

This user and maintenance manual contains important information about protecting the health and safety of the personnel who intend to use this apparatus. You must read and look after it carefully, making sure that it is available at all times for the operators who intend to consult it.

## 2. GENERAL DESCRIPTION

The **Mini-SUMO** lubrication pump series is particularly suited for dual line systems and progressive systems and can be adapted to many needs without making mechanical changes, even after installation is complete. In fact, by selecting from a set of components that are perfectly compatible with each other and easily assembled, it is possible to vary the pressure, the quantity of the delivered lubricant, the type of lubricant and the type of distribution.

This constructive technique is main based on the following modules:

- Electric motor
- Pump body
- Two pumping elements
- Tank
- Outlet valves and unit (inverter, pressure control valve, etc.).

There is one load bearing structure for all versions, the dual pumping element constitutes the essential module.



The pump unit has only one outlet.

Two types of grease tanks and two for oil, with different volumes (10 or 30 kg) can be positioned on the pump casing, with spatula and level indicators.

The electric **Mini-SUMO** pump is fully protected against the external environment and can run without problems in the most severe ambient conditions.

## 3. MACHINE IDENTIFICATION

Machine identification label is located on the front side of the reservoir and contains product serial number, input voltage and details of the operating parameters.

PRODUCT IDENTIFICATION TEST CERTIFICATE	
PART NUMBER	2487000
VAR	
PACK QUANTITY	xxx
GREASE ELECTRIC PUMP STATION	
FLOW	25 cc/min
VOLT	220/380V 50Hz
PRESSURE	380 bar Max
TANK	10 Kg Max
GREASE	MAX NLGI 2
WO: IT- xxxxxxxx - 0001	
	 Dropsa SpA, Milan Italy Year: 2014 <b>MADE IN ITALY</b>
Scan for Info Scannen für Info Telechargez-info Info Prodotto 扫描产品信息 Сканер штрих-кода	
<a href="http://www.DropsA.com">www.DropsA.com</a>	

## 4. TECHNICAL SPECIFICATIONS

GENERAL CHARACTERISTICS	
Empty weight (10 Kg tank)	35 Kg
Empty weight (30 Kg tank)	39 Kg
ELECTRICAL CHARACTERISTICS	
Motor power supply	380÷415Y 220÷240Δ - 50÷60Hz - 1340 rpm } Three-phase 4p 440÷480Y 255÷280Δ - 60Hz - 1610 rpm }  110 V 50 Hz (1370 rpm) } Single-phase 4p 230 V 50 Hz (1370 rpm) }  24 V CC 2800 rpm <sup>(1)</sup>
Rated motor power	0.18 Kw
Motor degree of protection	IP 55
Minimum and maximum level	Laser-ultrasounds
HYDRAULIC CHARACTERISTICS	
Pumping system	Piston
Flow rate (per pumping element)	25 cc/min - 42 cc/min <sup>(2)</sup>
Maximum operating pressures	380 bar – 300 bar <sup>(3)</sup> - 250 bar <sup>(4)</sup> – 250 bar <sup>(3)</sup> – 200 bar <sup>(4)</sup>
Outlet connection	G3/8" BSP
Tank capacity	10-30 Kg
Loading filter	Degree of filtering 300 μ
By-pass	Adjustable 0÷380 bar – precalibrated 300 bar
Temperature of use	- 5 ÷ + 50 °C
Operating humidity	90 % rel. humidity
Permitted lubricants <sup>(5)</sup>	Mineral lubricating oil min 32 cSt; grease max NLGI2
Storage temperature	-20 ÷ +65 °C

**N.b. The specifications refer to the temperature of use of +20°C (+68°F)**

<sup>(1)</sup> Max continuous operating time at maximum pressure 10min with pause of 30 min. (ratio 1:3) <sup>(2)</sup> With 24 V cc motor <sup>(3)</sup> With single-phase 230 V-50 hz motor <sup>(4)</sup> With single-phase 110 V-50 hz motor <sup>(5)</sup> If a different product is used, please contact Dropsa S.p.A. to ensure it is suitable for use.

### 4.1 HYDRAULIC SYSTEM

The hydraulic diagrams related to the different configurations that can be obtained using the available accessories are shown below (see paragraph 11)

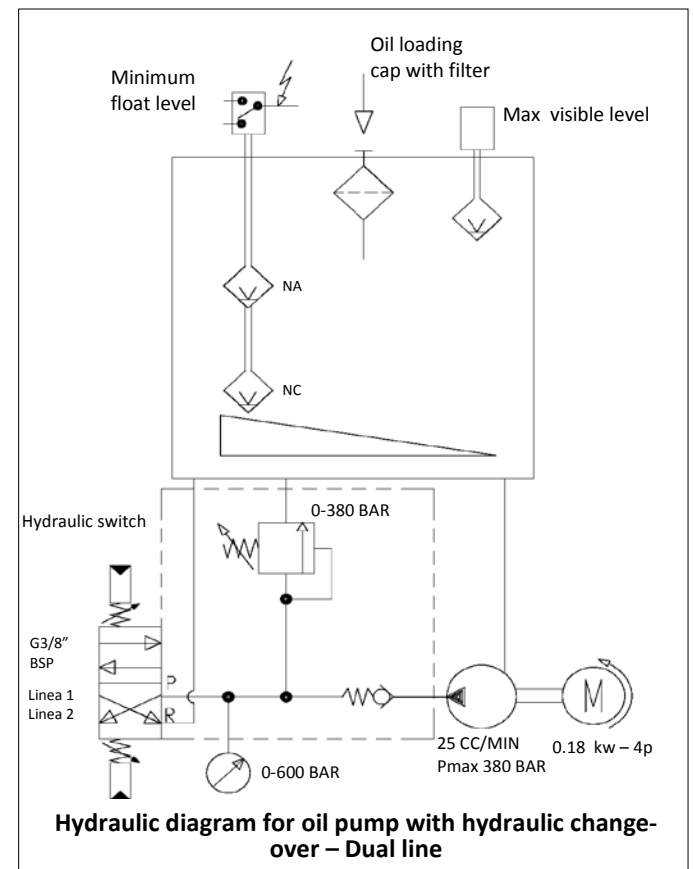
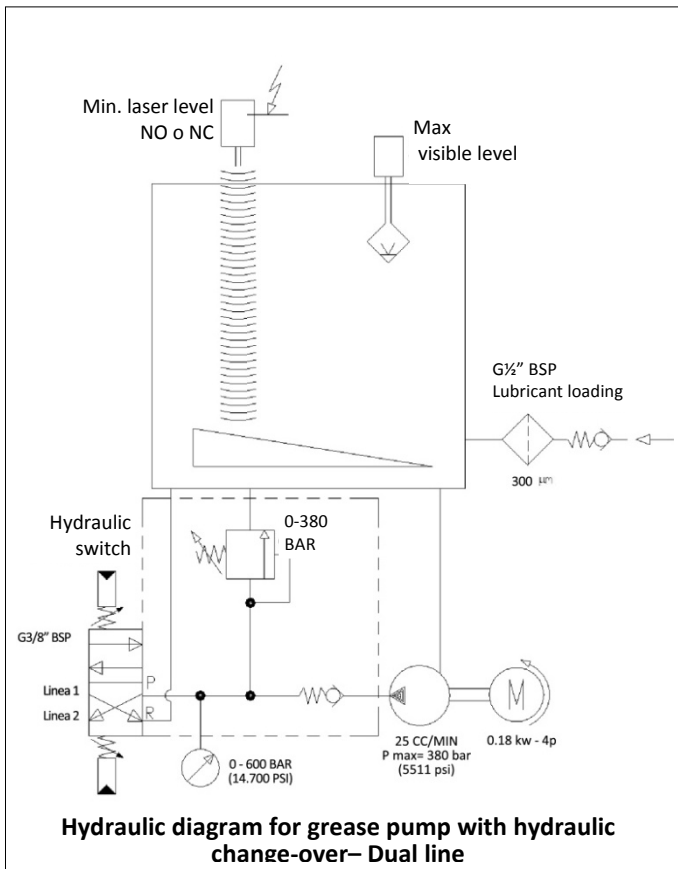
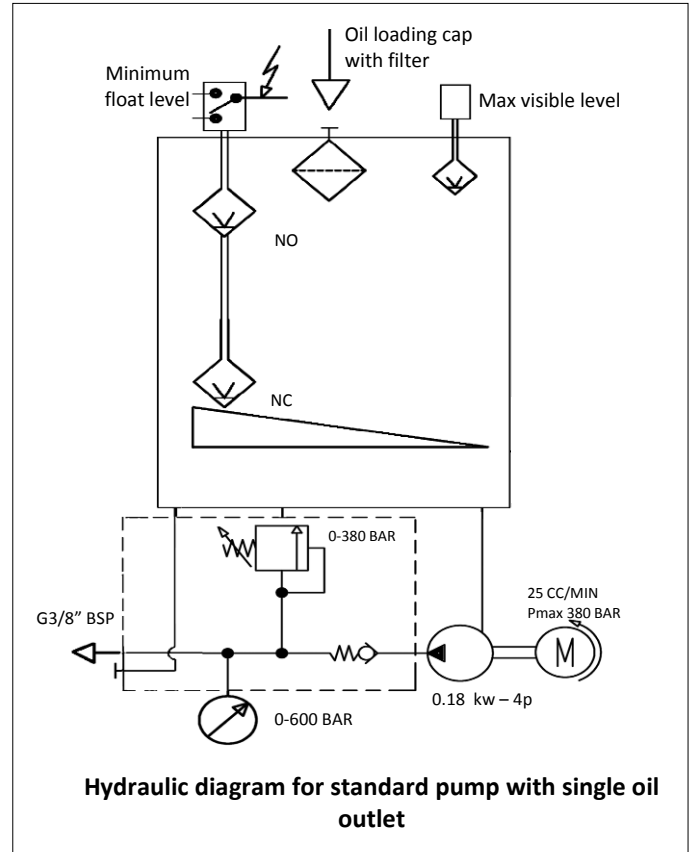
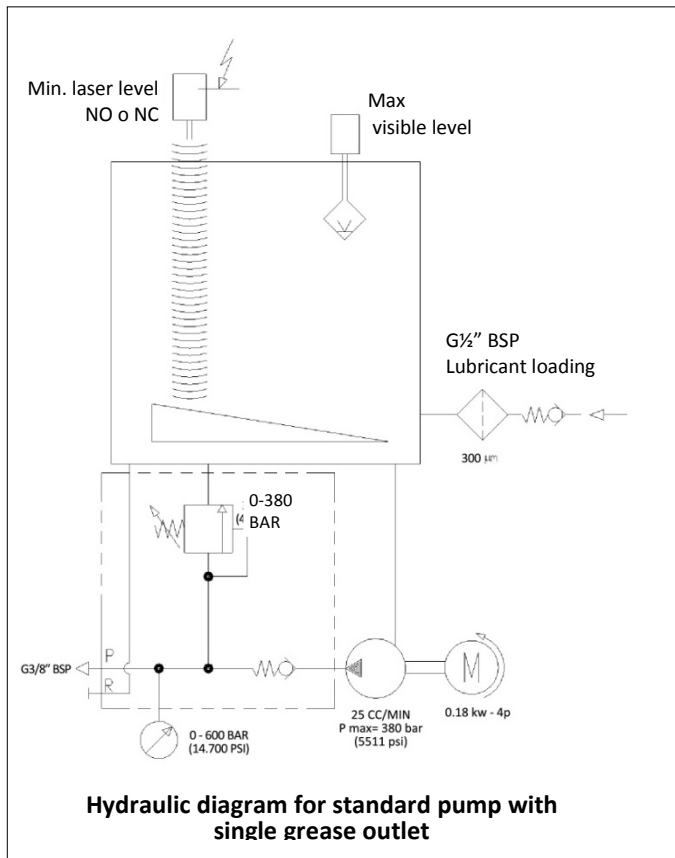

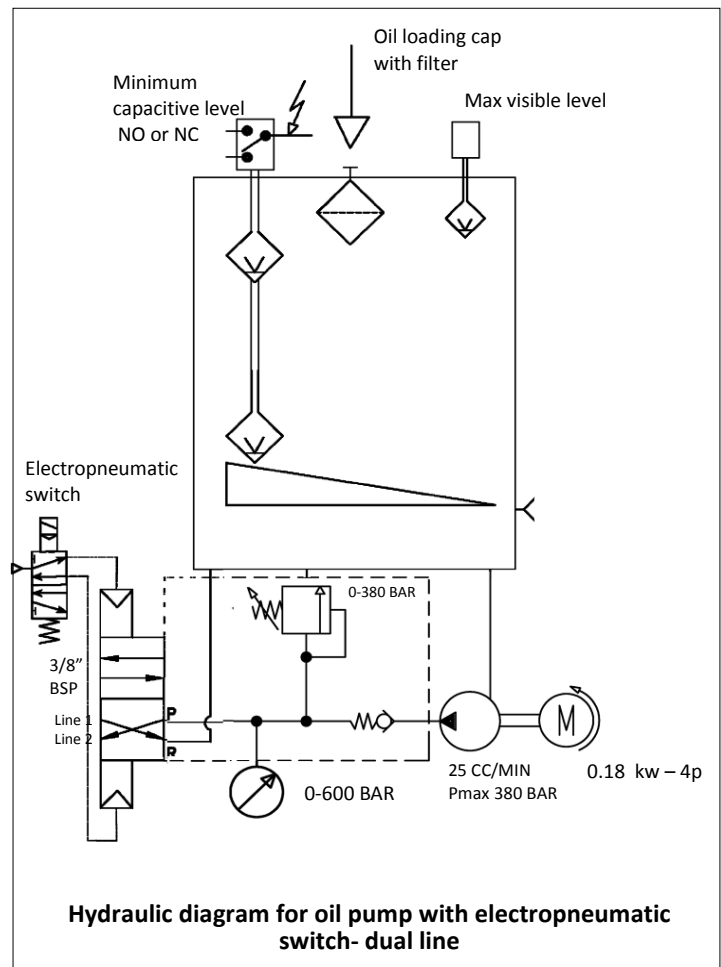
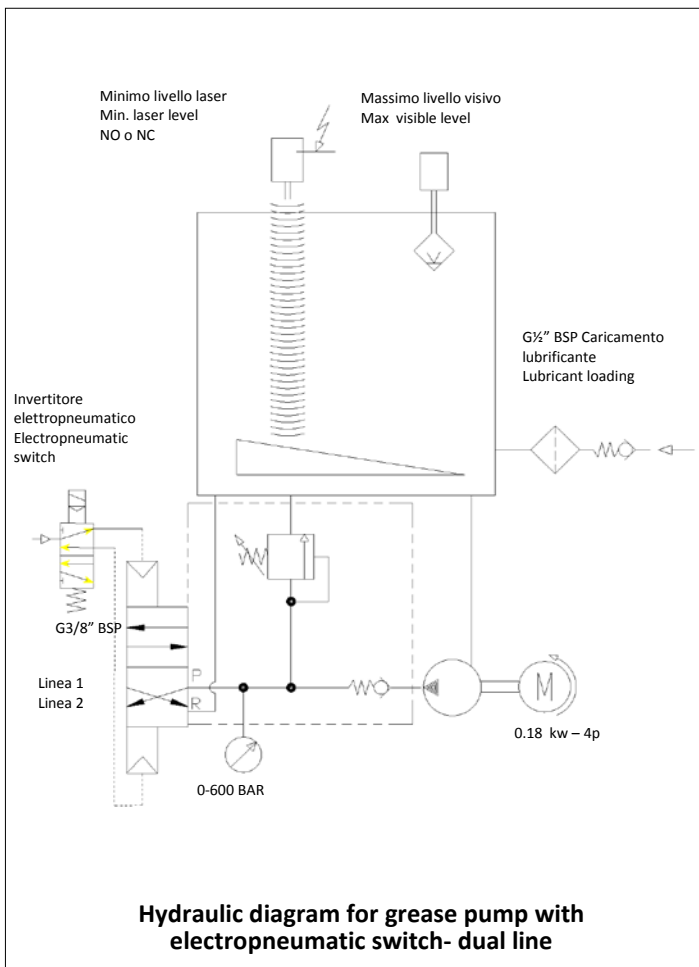
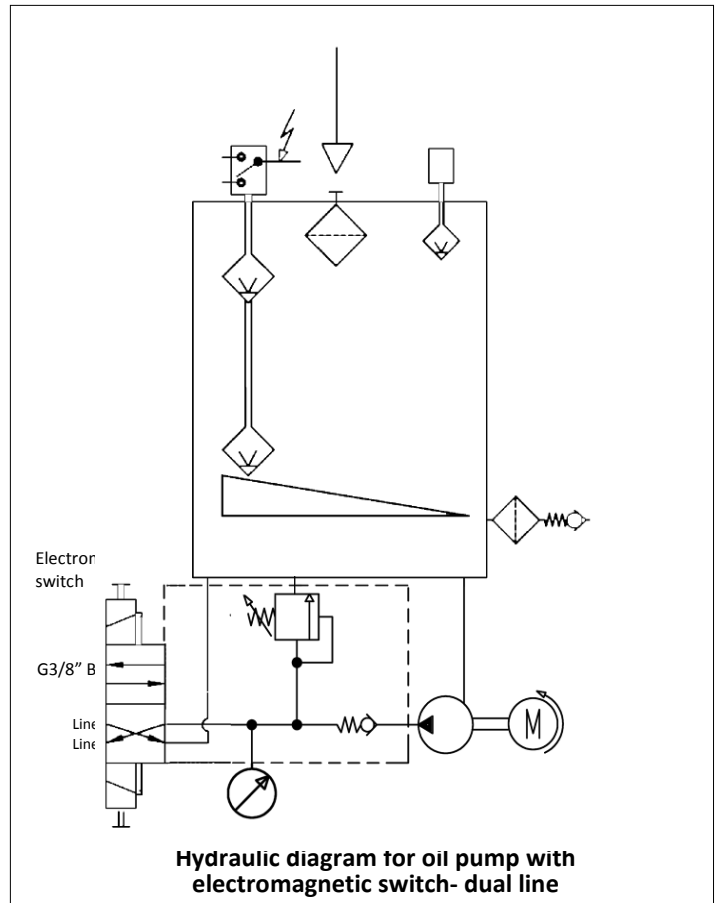
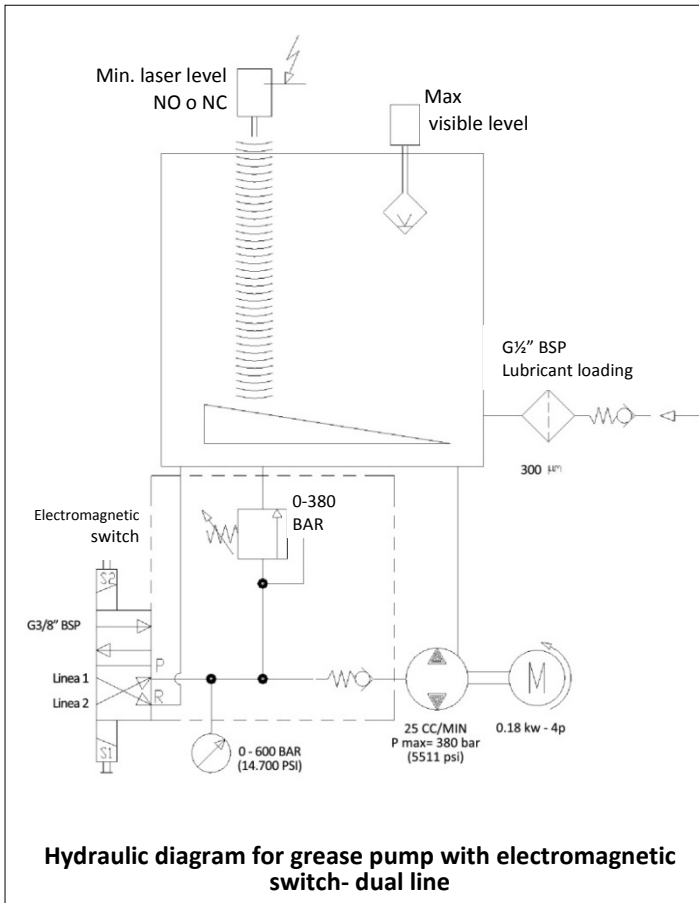

## 5. MACHINE COMPONENTS

### 5.1. STANDARD PUMP COMPONENTS

#### 5.1.1 FIXED FLOW RATE PUMPING ELEMENTS

The pump may be configured with two fixed flow rate pumping elements (25 cm<sup>3</sup>/ min for each pumping element). The seal between the piston and pumping element casing is dry, as the insertion of a gasket is not required.

The check valve for the pumping element has a cone-shaped seal. This solution guarantees optimal system sealing at high operating pressures (max pressure of 380 bar).

The pumping elements are mounted on the pump casing without the need to disconnect the line pipes with a threaded connection, which makes assembly/disassembly easier.

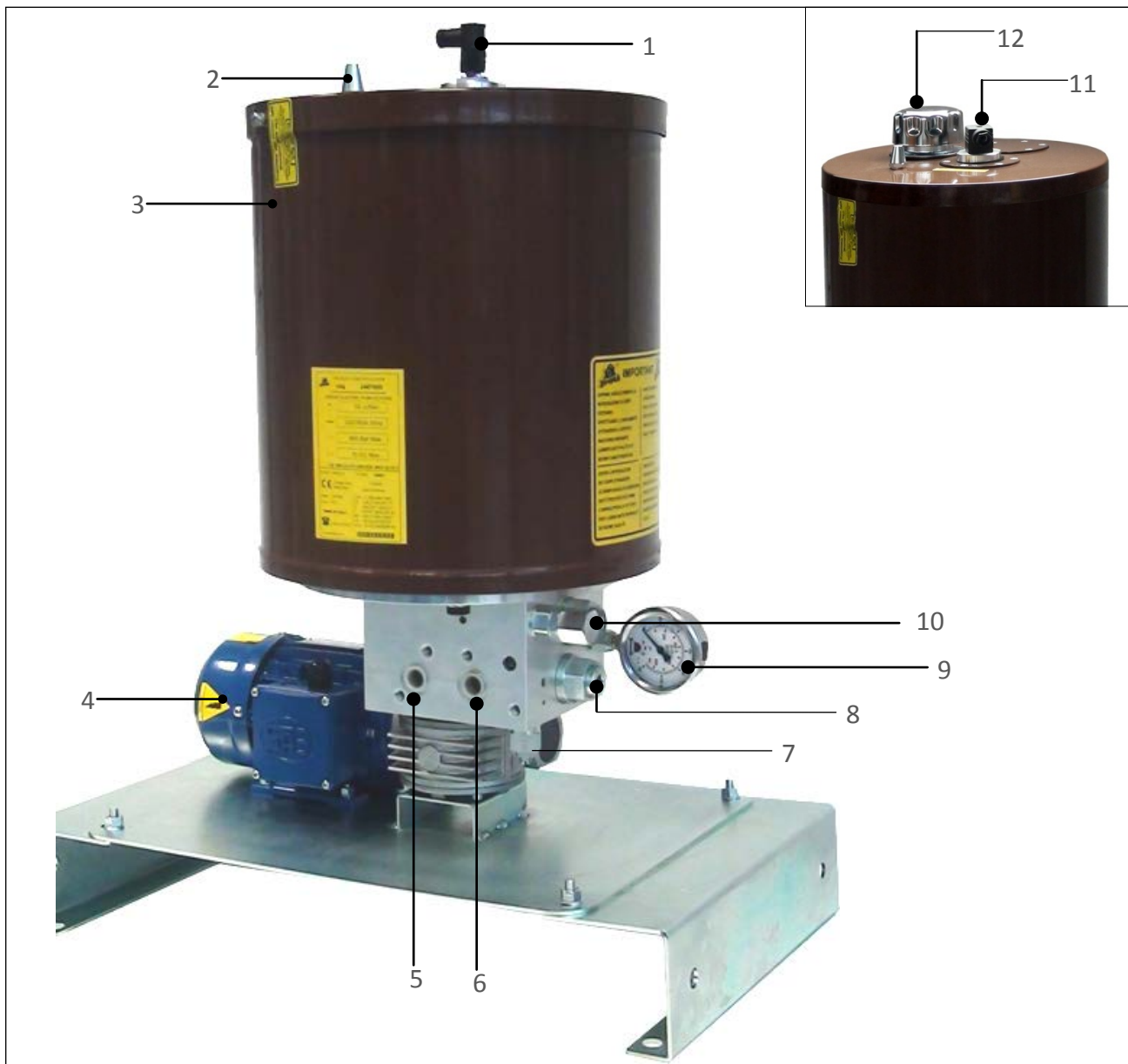

**STANDARD PUMP COMPONENTS**

1	Minimum laser level (for grease pump)	7	By-pass
2	Maximum level	8	Pumping system
3	Tank	9	Pressure gauge
4	Ratio motor	10	Loading (for grease pump)
5	Return	11	Minimum tank level (for oil pump)
6	Delivery	12	Lubricant loading cap (for oil pump)

### 5.1.2 MINIMUM AND MAXIMUM GREASE LEVEL INDICATORS

The standard grease pumps have two level types:

- Minimum laser level (for 10 and 30 Kg reservoir);
- Max visible level (floating).

### 5.1.3 Minimum laser level

The minimum level is realised by a laser probe. When the lubricant reaches minimum level, the laser probe signals the lack of lubricant. The probe has two outputs, the first NO and the second NC when lubricant is present. When the minimum level is reached, the probe signals that the lubricant is low.

The minimum level contact is indicated by a light signal on the electric panel. In addition the panel controls any automatic reservoir filling pump command.

### 5.1.4 Max visible level (floating)

The phase that the lubricant is loaded in the tank is realised by the operator, who uses a pump.

Once the maximum lubricant level is reached, a rod is activated that indicates that the tank is full.

### 5.1.5 MINIMUM AND MAXIMUM OIL LEVEL INDICATORS

The standard oil pumps have two level types:

- Minimum and maximum level with a float;
- Max visible level (floating).

### 5.1.6 Minimum and maximum level with a float

A rod probe with a dual float mounted on the pump cover makes it possible to read the minimum oil level (reserve) and the maximum level (which makes it possible to stop automatic tank filling).

The minimum level contact is indicated by a luminous signal on the electric panel, it also controls any automatic tank filling pump command.

### 5.1.7 SPATULA FOR GREASE AND OIL (STANDARD VERSION)

Two tanks have been foreseen with capacities of 10 and 30 kg. (22 – 66.1 Lb) two for oil and two for grease.

The tanks are supplied standard with a spatula and a scraper, which must not be disassembled during their assembly or replacement. Under the spatula, there is a standard electrogalvanised steel mesh with 0.5 mm holes (0.02 in.). The pump is protected from possible foreign bodies that could be inadvertently present while the tank is being loaded.

## 5.2. OPTIONAL PUMP COMPONENTS

### 5.2.1 Interchangeable electromagnetic change-over

An electromagnetically controlled inverter is available for dual line operation. The inverter can be replaced in the case of damage without having to disconnect the two line pipes (interchangeable version). This reduces the maintenance time and the time the plant is stopped.

The main change-over parts are:

- a casing with a central lapped hole that makes it possible to make a dry seal connection with the inversion piston, which is facilitated by a balancing system;
- a ground piston with a dual coupling surface, with grooves that improve lubrication and the seal at high pressures;
- sealing gaskets that can support high pressure levels, by means of a pressurised chamber, optimising the inverter function;
- Two control electro-magnets

Advantages:

- easy to assemble and disassemble without disconnecting the line tubes
- Minimum time the plant is stopped.





### 5.2.2 Electro pneumatic change-over

The main change-over parts are:

- a casing with a central lapping hole that makes it possible to make a dry seal connection with the inversion piston, which is facilitated by a balancing system;
- a ground piston with a dual coupling surface, with grooves that improve lubrication and the seal at high pressures;
- the inversion phase is facilitated by a balancing system;
- sealing gaskets that can support high pressure levels, by means of a pressurised chamber, optimising the inverter function;
- Two single acting pneumatic actuating cylinders, controlled by a 5/ 2 type solenoid valve.



Photo 4



**GENERAL NOTE FOR ALL ELECTROMAGNETIC INVERTERS:**

A 2-5 second de-energising delay should be set for the electromagnets to permit them to complete their inversion after the closing time for the end of line pressure switch.

### 5.2.3 Hydraulic change-over (optional)

The pump can also be equipped with a hydraulic change-over valve that activates when the pressure is made on each line. The pressure indicator is equipped with a pin that allows the operator to visualize the operation of the valve. The valve can also be equipped with cycle sensor (certified for hazardous areas) to monitor the inversion phases of the valve.



### 5.2.4 ELECTRIC EQUIPMENT

“DROPSA” electric equipment has been designed with the purposes of supplying a system that is complete with all commands necessary for the automatic operation controlled by safety signals for centralised lubrication systems. The primary voltage is 400 VAC and 50 Hz, other voltages are provided upon request. For more information about the available versions, contact the Dropsa technical sales department.

Type of probe	Type of inverter	Voltage V	Code Electrical apparatus VIP5 PRO	Code Electrical apparatus VIP5 PLUS	Code Electrical apparatus with PLC
LASER PROBE (24V cc standard version) Out NO e NC (1 threshold)	Electromagnetic	24 VDC	1639211	1639210	1637008
		110 VAC	*	*	1637009
		220 VAC	*	*	1637010
	Electro pneumatic	24 VDC	1639211	1639210	1637011
		110 VAC	*	*	1637012
		220 VAC	*	*	1637013
LASER PROBE 24V cc Out 4÷20mA/2 NO (4 thresholds)	Electromagnetic	24 VDC	1639211	1639210	1637001
		110 VAC	*	*	1637003
		220 VAC	*	*	1637004
	Electro pneumatic	24 VDC	1639211	1639210	1637005
		110 VAC	*	*	1637006
		220 VAC	*	*	1637007



\* Contact the sales office Dropsa for other primary and the inverter supply voltages.

## 6. UNPACKING AND INSTALLATION

---

### 6.1 UNPACKING

Once the suitable location for installation has been identified, open the package and remove the pump. Check that it was not damaged during transport or storage. The packaging material does not require special disposal precautions as it is not in any way dangerous or polluting. Refer to the local regulations for disposal.

### 6.2 INSTALLATION

Pump assembly operations are not required.. The pump is fixed on a metal pallet that permits safe handling with a transpallet or fork lift truck. The pallet was designed to be installed in the plant. It has four  holes suitable for fixing to the floor. Suitable space must be provided (as shown in the installation diagram) to prevent abnormal positions or the possibility of impacts. Then, as described above, the pump must be connected hydraulically to the machine and then the connection to the control panel must be made.

## 7. INSTRUCTIONS FOR USE

---

### 7.1 STARTING THE PUMP

Before using the MINI SUMO pump, a few preliminary checks must be performed:

- Check the integrity of the power supply cable and the unit prior to use.
- If there is damage to the power supply cable or the unit, do not start operations!
- Replace the damaged power supply cable with a new one.
- The unit may only be opened and repaired by specialised personnel.
- In order to prevent the danger of electrocution due to direct or indirect contact with live parts, the electric power supply line must be suitably protected by a specific differential magnetothermic switch, according to regulations and with rated breaking capacity at list equal to prospective fault current at installation point.
- It is prohibited to use the pump if submersed in fluids or in a particularly aggressive or explosive/inflammable environment if not previously prepared for that purpose by the supplier.
- Use safety gloves or glasses as specified in the safety sheet for the lubricating oil
- DO NOT use aggressive lubricants with NBR gaskets. In the case of doubt, contact the Dropsa SpA technical office to receive a detailed card about the recommended oils.
- Do not ignore the hazards to health and comply with the health regulations.



**ATTENTION:** All components must be ground connected. This applies both to electric components as well as to control devices. For this purpose, make sure that the ground wire is directly connected. For safety reasons, the ground conductor must be approx. 100 mm longer than the phase conductors. If the cable is accidentally disconnected, the ground terminal must be the last to be disconnected.

- Check the integrity of the pump.
- Check that the pump is at the operating temperature and that there are no air bubbles in the pipes.
- Check that the electric connection was carried out correctly.
- Once the pump has started, check that the direction of rotation of the electric motor is as indicated by the arrow on the motor's protective casing; if it rotates backward; reconnect it as shown in the wiring diagram provided with the motor.

### 7.2 INSTRUCTIONS FOR USE

- 1) Press the start button on the machine to which the pump is connected or start it;
- 2) Check that the pump starts;
- 3) To change the pressure value, turn the adjustment screw (see Chap. 5). Turn it clockwise to increase the pressure or counter clockwise to decrease it;
- 4) Check that the machine lubrication is suitable (if there are doubts about correct operation, the Dropsa SpA technical office can be contacted to request the inspection procedure).

**7.2.1 LASER PROBE SETTING, 24V CC OUT NO E NC (1 threshold)**

1. Reference notch.
2. Yellow led: lights when the set value is reached, (outlet=ON).
3. Lock ring.
4. Setting lock ring (be adjusted manually after unlocking).
5. Green led: indicates the correct power supply (24V cc).

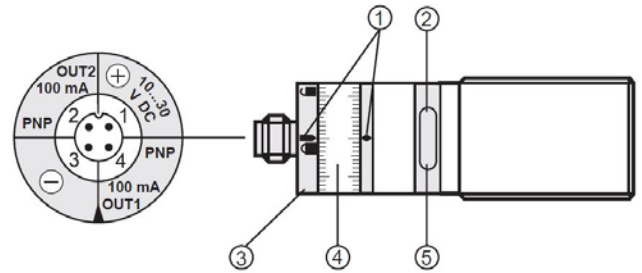

\* To obtain a correct setting bring the lock ring to maximum setting value and then down to desire value.

On the pump is placed a label that shows the wiring diagram and setting values. The pump is normally equipped with pre setting sensor to "L" thresholds (minimum level). Whereas other thresholds: MM (absolute maximum level), M (absolute level), LL (absolute minimum level), can be set by the user.

**Attention you can only set one thresholds at a time**

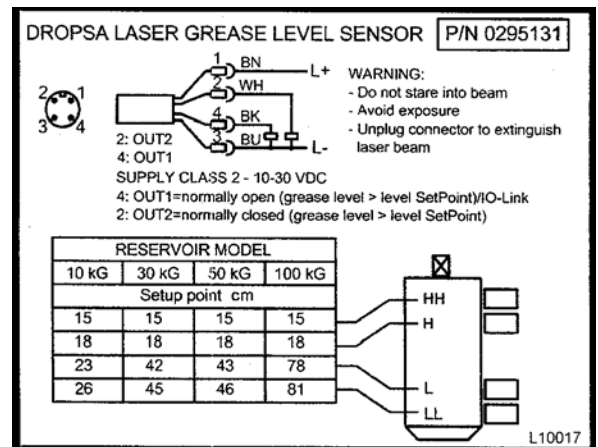

**7.2.2 Procedure for calibrating the capacitive probe nc (optional)**

Before being assembled the capacitive probe must be calibrated in accordance with the following sequence:

1. connect the sensor electrically;
2. immerse the sensor in the lubricant, down to half of its length;
3. remove the sensor from the lubricant until it skims the surface of the lubricant;
4. at this point there can be two possible types of operation:
  - If its status does not change its sensitivity must be reduced (by acting on the screws for adjusting sensor sensitivity) until its state of excitation is reached.
  - if its status changes, the sensor already possesses the correct sensitivity
5. after checking that the sensor has been correctly read, the sensor reading must be repeated at least three times
6. Tighten the capacitive probe on the probe carrier rod, complying with the following assembly height:
  - 450 mm (from below the cover up to the lower surface of the sensor) for a 30 kg tank
  - 900 mm (from below the cover up to the lower surface of the sensor) for a 100 kg tank.

**Operating instructions for the capacitive probe (model Sc30sp-a20 no)**

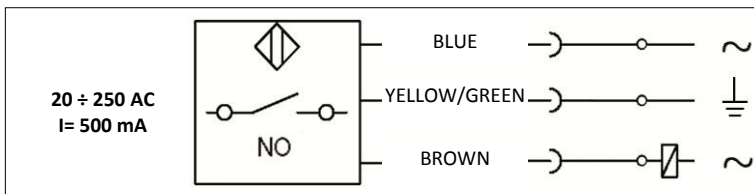

**Sensors in version with alternate current (2 wires)**

These are amplified sensors AC. In this version, the standard characteristics of the sensors include protection against permanent load short circuit, and protection against the peaks produced when the inductive loads are disconnected.

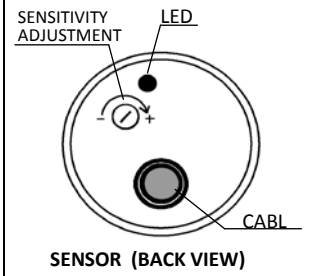

### 7.2.3 Procedure for calibrating the laser probe 24V cc Out 4÷20mA/2 NO (4 thresholds)

The laser probe has an on-board viewing and programming display. It is possible to work in analogue (with a 4 to 20 mA signal) or digital (two outputs and four intervention thresholds) mode. The table with the laser probe calibration parameters is shown below.

**Figure 6**

LASER PROBE CALIBRATION							
Pos.	Level	Output signal	Set-up	10 kg Reservoir		30 kg Reservoir	
				Height X [mm]	Grease quantity [kg]	Height X [mm]	Grease quantity [kg]
A	Absolute maximum level	OUT 2= Fno	nsP2	220	11	220	23
C	Minimum level		fsP2	300	5	490	5
B	Maximum level	OUT 1= Fno	nsP1	250	9	250	21
D	Absolute minimum level		fsP1	330	3	520	3

### 7.2.4 CALIBRATION THRESHOLDS OF THE ULTRASOUND PROBE (optional)

The green led indicates the probe is powered. Yellow LED indicates the operating mode of reading. Below the table with the calibration parameters of ultrasound probe, for 10 and 30 kg reservoirs.

**Figure 7**

ULTRASOUND PROBE CALIBRATION						
Pos.	Level	Output signal	Reservoir 10 kg		Reservoir 30 kg	
			Height X [mm]	Grease quantity [kg]	Height X [mm]	Grease quantity [kg]
A	Absolute maximum level	1 threshold	110	10	110	25
B	Absolute minimum level	2 threshold	270	4	490	2

**NOTE:** To change calibration thresholds of laser and ultrasound probes contact DROPSA staff

## 8. PROBLEMS AND SOLUTIONS

**ATTENTION:** The machine may only be opened and repaired by authorised Dropsa personnel.

A diagnostics table is provided below that indicates the main anomalies, the probable causes and the possible solutions. If you were not able to solve the problem after consulting the diagnostics table, do not try to find the fault by disassembling machine parts but contact the Dropsa technical office and report the anomalies that have been discovered, with a detailed description.

PROBLEM	CAUSE	SOLUTION
The electric pump does not deliver lubricant.	<p>The electric motor is not operating.</p> <p>The tank is empty.</p> <p>The pump does not prime. Cause for the pump not priming:</p> <ul style="list-style-type: none"> <li>• The motor is rotating in the inverse direction (clockwise);</li> <li>• The motor is rotating in the correct direction, but the spatula is not rotating;</li> <li>• Air bubbles in the lubricant.</li> </ul> <p>The pressure control valve (bypass) was calibrated at a value that is too low Presence of dirt in the non-return valve</p>	<p>Check the connection between the motor and the electric power supply line.</p> <p>Check the motor windings.</p> <p>Check that the motor terminal board connection plates have been positioned according to the power supply voltage.</p> <p>Fill the tank. Attention: if the tank emptied itself and the electric signal indicating that the minimum level was reached was not given, check the minimum level contact.</p> <p>Remove the tank cover and check that the spatula rotates clockwise and moves the lubricant; otherwise, invert two of the three motor phases. See above.</p> <p>Disconnect the pump delivery pipe and bleed the lubricant until the air bubbles have been eliminated.</p>
The pump does not pressurise.	There may be dirt on the pumping element check valve cone.	Clean the pumping element check valve cone and seat, bleeding the lubricant.
No minimum level signal when there is no lubricant in the tank.	Minimum level incorrectly regulated.	Check the correct operation of the level probe as follows: Check the correct level adjustment of laser probe.
Minimum level selection, with lubricant below the minimum and pump operating.	Minimum level incorrectly regulated.	The control panel lamp always remains on: check the electric connection and replace the laser probe if necessary.

## 9. MAINTENANCE PROCEDURES

The pump was designed and built in order to minimise maintenance requirements.

To simplify maintenance, it is recommended to install it in an easy to reach position.

- Periodically check the pipe joints to detect any leaks. Furthermore, always keep the pump clean to be able to quickly detect any leaks or defects.
- Check if the loading filter is clean after every 2000 hours of operation.

The machine does not require any special equipment for any control and/or maintenance activity. It is recommended to use tools and personal protective devices suitable for use (gloves) and that are in good condition according to current regulations to prevent damage to people or machine parts.



**ATTENTION:** Make sure that the electric and hydraulic power supplies are disconnected before carrying out any maintenance work.

In the case of doubts and/or problems that cannot be solved, do not try to discover the reason by disassembling machine parts, but contact the DROPSA S.p.A technical office.

## **10. DISPOSAL**

---

During machine maintenance, or if it is demolished, do not dispose of the polluting parts in an improper manner. Refer to the local regulations for their correct disposal. When demolishing the machine, the identification plate and all other documents must be destroyed.

# 11. ORDER INFORMATION

## 11.1 STANDARD VERSIONS

			1°	2°	3°	4°	5°	6°	
<b>MINISUMO PUMP Order CODE</b>									
<b>STANDARD VERSIONS</b>	MINISUMO GREASE Pump, 10 Kg 3ph-0.18kw		2487000	0	0	0	0	0	
	MINISUMO GREASE Pump, 10 Kg 1ph-0.25kw - 110V		2487010	0	0	0	0	0	
	MINISUMO GREASE Pump, 10 Kg 1ph-0. 25kw - 230V		2487011	0	0	0	0	0	
	MINISUMO GREASE Pump, 10 Kg 24V Cc		2487012	0	0	0	0	0	
	MINISUMO GREASE Pump, 30 Kg 3ph-0.18kw		2487001	0	0	0	0	0	
	MINISUMO GREASE Pump, 30 Kg 1ph-0. 25kw - 110V		2487013	0	0	0	0	0	
	MINISUMO GREASE Pump, 30 Kg 1ph-0. 25kw - 230V		2487014	0	0	0	0	0	
	MINISUMO GREASE Pump, 30 Kg 24V Cc		2487015	0	0	0	0	0	
	MINISUMO OIL Pump, 10 Kg 3ph-0.18kw		2487050	0	0	0	0	0	
	MINISUMO OIL Pump, 10 Kg 1ph-0. 25kw - 110V		2487060	0	0	0	0	0	
	MINISUMO OIL Pump, 10 Kg 1ph-0. 25kw -230V		2487061	0	0	0	0	0	
	MINISUMO OIL Pump, 10 Kg 24V Cc		2487062	0	0	0	0	0	
	MINISUMO OIL Pump, 30 Kg 3ph-0.18kw		2487051	0	0	0	0	0	
	MINISUMO OIL Pump, 30 Kg 1ph-0. 25kw - 110V		2487063	0	0	0	0	0	
	MINISUMO OIL Pump, 30 Kg 1ph-0. 25kw - 230V		2487064	0	0	0	0	0	
MINISUMO OIL Pump, 30 Kg 24V Cc		2487065	0	0	0	0	0		
		<b>DESCRIPTION</b>	<b>DROPSA CODE</b>	<b>CODE</b>					
<b>Minimum Level</b>		STANDARD GREASE VERSION with laser sensor 24V cc Out NO e NC (1 threshold)	0295131 (per 10/30 kg)	0	From 0 To 9 From A To Z From 0 To 9 From A To Z From 0 To 9				
		STANDARD OIL VERSION With Floating Reed	0295151 (For 10 Kg) 0295150 (For 30 Kg)						
	<b>Variants</b>	Min-max laser level Kit 24V cc Out 4÷20mA/2 NO (4 thresholds)	0295130	2					
		Pump Ultrasound Level Kit 10 Kg	0295140	3					
		Pump Ultrasound Level Kit 30 Kg							
		Capacitive Level Kit 10 Kg (250 V AC)	0295123	5					
Capacitive Level Kit 30 Kg (250 V AC)	0295121	6							
<b>Maximum Level</b>		STANDARD GREASE VERSION	0295100 (For 10 Kg And 30 Kg)	0					
		STANDARD OIL VERSION With Floating Reed	0295151 (For 10 Kg) 0295150 (For 30 Kg)						
	<b>Variant</b>	Laser sensor 24V cc Out NO e NC (1 threshold)	0295131 (For 10 kg and 30 kg)	A					
<b>Pumping Elements</b>		STANDARD ONE FIXED FLOW RATE PUMPING ELEMENT	0297010 + 0297017	0					
		Two Fixed Flow Rate Pumping Elements	0297010-0297010	1					
<b>Electromagnetic Inverter With Sub-Base</b>		STANDARD NOT PROVIDED		0					
	<b>Variants</b>	24 V DC	0083560	A					
		110 V AC	0083491	B					
		230 V AC	0083492	C					
		380 V AC	0083493	D					
<b>Electropneumatic Switch</b>	<b>Variants</b>	24 V DC	0083494	G					
		24 V AC	0083495	H					
		110 V AC	0083496	J					
		230 V AC	0083497	K					
<b>Hydraulic change-over</b>	<b>Variants</b>		0086450	L					
<b>Heating Band</b>	<b>Variants</b>	STANDARD NOT PROVIDED		0					
		10 Kg Pump Heating Band 110V-150W	0295066	1					
		10/30 Kg Pump Heating Band 230V-150W	0295103	2					
<b>CODE EXAMPLE FOR MINISUMO GREASE PUMP, 30 KG</b>			<b>Code</b>	2487000	2	0	1	A	0
Minimum Level		Pump Laser Level Kit 30 Kg	0295130	2					
Maximum Level		Standard Grease	0295100	0					
Pumping Element		Two Fixed Flow Rate Pumping Elements	0297010-0297010	1					
Electromagnetic		24 V DC	0083490	A					
Heating Band		Not Provided		0					

			Order CODE For MINISUMO OIL PUMP, 30 Kg						
Code Example For MINISUMO OIL PUMP, 30 Kg			Code	2487050	0	A	1	J	1
Minimum Level		STANDARD OIL VERSION With Floating Reed	0295150	0					
Maximum Level		Laser sensor 24V cc Out NO e NC (1 threshold)	0295131	A					
Pumping Element		Two Fixed Flow Rate Pumping Elements	0297010-0297010	1					
Electropneumatic Switch		110 V AC	0083496	J					
Heating Band		30 Kg Pump Heating Band	0295066	1					

N.B. The following letters were eliminated from the alphabet:

- "O" to prevent creating confusion with the number 0
- "I" to prevent creating confusion with the number 1

## 11.2. OPTIONS

Description		Code
Oil conversion	Oil float min/max level kit 10 Kg (66lb) + Filling cap with filter	0295151+3130138
	Oil float min/max level kit 30 Kg (66lb) + Filling cap with filter	0295150+3130138
Terminal board kit	Terminal board support to assemble on board the metal pallet	3133906

## 11.3 SPARE PARTS

Spare part description		Variant	Code
Motors	3 Ph - 0,18 Kw - 230Δ/400Y 50Hz - 1350 rpm 277Δ/480Y 60Hz - 1620 rpm		0297002
	UL-CSA - 3 Ph - 0,18 Kw - 330Δ/575Y 60Hz - 1690 rpm		3301574
	UL-CSA - 3 Ph - 0,18 Kw - 208Δ/360Y 60Hz - 1610 rpm 230Δ/400Y 60Hz - 1670 rpm 255Δ/440Y 60Hz - 1710 rpm		3301580
	1Ph - 0. 25 Kw - 110 V – 50 hz		3301558
	1Ph - 0. 25 Kw - 230 V – 50 hz		3301559
	24 V – CC		3301557
Reducer i=35			0297001
Maximum mechanical level kit 10 and 30 Kg (grease)			0295100
Laser probe assembly 10÷30 Kg - 24V cc Out NO e NC (1 threshold)			0295131
Laser probe assembly 24V cc Out 4÷20mA/2 NO (4 threshold) - 10 kg		VAR 1	0295130
Laser probe assembly 24V cc Out 4÷20mA/2 NO (4 threshold) - 30 kg		VAR 2	
Minimum capacitive level kit (250V AC) 10 Kg (grease)			0295123
Minimum capacitive level kit (250V AC) 30 Kg (grease)			0295121
Continuous reading ultrasound level 4..20 mA 10 kg		VAR 4	0295140
Continuous reading ultrasound level 4..20 mA 30 kg		VAR 5	
Minimum and maximum level with float 10 Kg (oil)			0295151
Minimum and maximum level with float 30 Kg (oil)			0295150
Grease loading filter			0297007
by-pass			0234496
Tank-pump casing gasket			3190485
Pressure gauge 0 - 600 Bar			3292167
Pumping			0297010C



## 12. DIMENSIONS

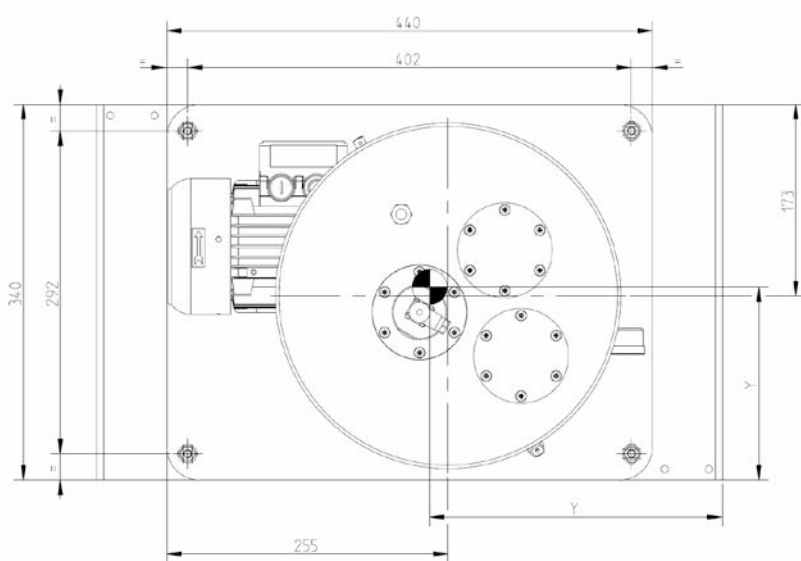
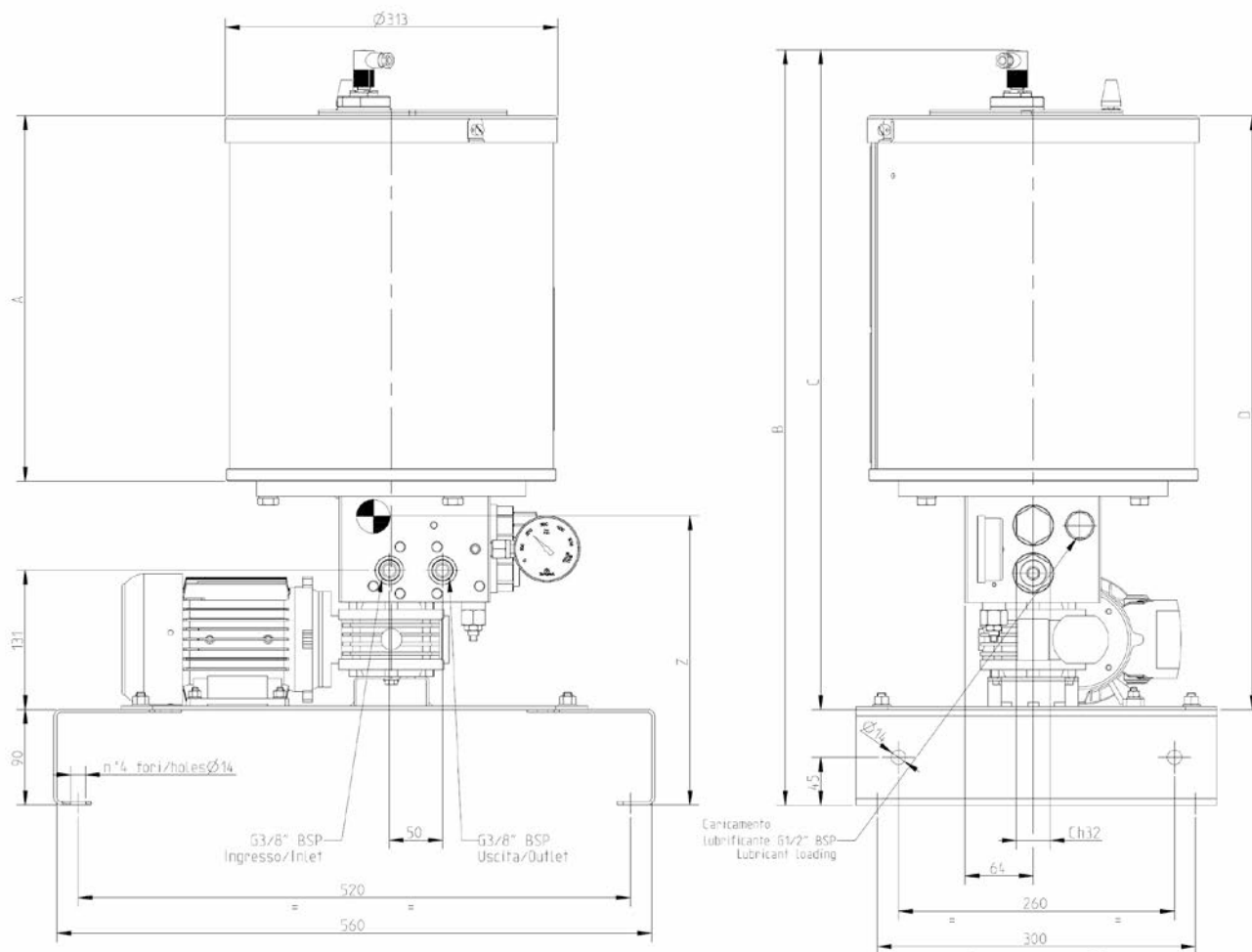

	10 Kg	30 Kg
<b>A</b>	344,5	533,5
<b>B</b>	803	994
<b>C</b>	688	879
<b>D</b>	577	768
<b>Z</b>	275	325
<b>X</b>	265	265
<b>Y</b>	175	175

## 13. HANDLING AND TRANSPORT

Transport and storage are carried out using a metal pallet with packaging on the side and a wood cover.

The pump is fixed on a metal pallet that permits safe handling with a transpallet or fork lift truck. The metal pallet was designed to be installed in the plant. It has four  $\varnothing$  14 mm holes suitable for fixing to the floor.



Lift the equipment according to the direction shown on the cardboard package.

The machine components can support storage temperatures between

-20 to + 65 °C; however, to prevent damage, the machine must only be started up after the machine has reached a temperature of +5 °C.

## 14. PRECAUTIONS FOR USE

The warnings about the risks involved in using a pump for lubricants must be read.

The operator must understand its operation and clearly understand the hazards connected to pumping pressurised grease.

Therefore we recommend the following:

- Check the chemical compatibility of the material with which the pump is built with the fluid to be pumped (see chap. 4). An incorrect selection could cause, in addition to damaging the pumps and pipes, serious risks for people (spillage of irritating products that are harmful to health) and for the environment.
- Never exceed the maximum operating pressure permitted for the pump and the components connected to it. In the case of doubt, refer to the data specified on the machine plate.
- Only use original spare parts.
- If components must be replaced with others, make sure they are suitable for operating at the pump's maximum operating pressure.



**ATTENTION!** Never try to stop or deviate any leaks with your hands or other body parts.

**Note:** Personnel must use protective devices, garments and tools in compliance with current standards with regard to the location and the use of the pump both during work as well as during maintenance operations.



**ATTENTION:** The warnings about the risks involved in using a pump for lubricants must be read. The user must understand its operation using the user and maintenance manual.

### **Electric current**

Do not carry out any work on the machine before disconnecting it from the electrical power supply and making sure that no one can reconnect it during the operation. All the installed equipment (electric and electronic), tanks and basic structures must be connected to the ground line.

### **Inflammability**

The lubricant used in the lubrication circuits is normally not an inflammable liquid. It is however necessary to adopt all the possible measures to prevent that it comes into contact with very hot parts or open flames.

### **Pressure**

Before each operation, make sure there is no residual pressure in every branch of the lubrication circuit that could cause oil to spray when disassembling fittings or components. After long periods of inactivity, check the seal of all the parts subject to pressure. Do not subject the fittings, pipes and pressurised parts to violent impacts. Damaged flexible pipes or fittings are DANGEROUS and must be replaced.

Only original spare parts should be used.

### **Noise**

Under normal operating conditions, noise emission **does not exceed 70 dB "A"** at a distance of 1 metre (39.3 inches) from the pump.



**NOTE:** The pump was designed to operate with lubricants with a maximum rating NLGI 2.

Use lubricants that are compatible with NBR gaskets.

Any internal residual lubricant used for assembly and testing purposes is NLGI 2 oil

A comparison table is provided between the classification of NLGI lubricants (National Lubricating Grease Institute) and the ASTM classification (American Society for Testing and Materials) for greases for the values that concern the pump.

For further information about the technical specifications and the safety measures to adopt, refer to the product safety sheet (Directive 93/112/EEC) relative to the type of lubricant selected and supplied by the manufacturer.

GREASES	
NLGI	ASTM
000	445 – 475
00	400 – 430
0	355 – 385
1	310 – 340
2	265 – 295

## 15. GUIDELINES FOR USE

Compliance with the essential safety requirements and the provisions specified in the machine directive was checked by filling out prepared check lists that are contained in the technical file.

Two types of lists were used:

- Risk assessment (UNI EN ISO 14121-1).
- Compliance with the essential safety requirements Machine Directive –EC 06/42).

**The risks that were not completely eliminated, but considered acceptable, are specified below:**

- Electrocutation: this can only occur in the case of serious user incompetence.
- Use of unsuitable lubricant: the types of fluids that are not compatible with correct pump operation are listed below. \*
- Contact with harmful fluids.

FLUIDS THAT ARE NOT PERMITTED	
FLUIDS	RISKS
Lubricants with abrasive additives	wear of the components inside the pump
Lubricants with silicone additives	Pump seizure
Petrol – solvents – inflammable liquids	Fire – explosion – damage to the gaskets
Corrosive products	Pump corrosion - damage to people
Water	Pump oxidation
Food substances	They would be contaminated

\* For more detailed information regarding product compatibility with particular fluids, contact the Dropsa S.p.A. technical office