

Plug and Socket Devices CES 63 A

Series 8579



www.stahl.de



14507E00

- > Switch socket / plug 63 A
- > Large switch handle
 - with clear switch position indication
 - padlockable in 0- and I-position
- > Low insertion and withdrawal forces through individually encapsulated pins, flexibly embedded
- > Optimal contact by means of self-cleaning laminated contacts
- > With an integrated auxiliary contact for control and signalling purposes
- > With motor switching capacity AC-3 acc. to IEC 60947-3
- > IP66 in any application position



E3

The plug and socket devices of the Series SolConeX 8579 are 63 A versions. An important safety criterion is their reliable load disconnect switch with a highly visible position indication. Plugging in and unplugging is done easily and safely in 0-position. The plug and socket devices comply with IEC/EN 60309-1/-2 (CEE), IEC/EN 60079-0, IEC/EN 60079-1 and IEC/EN 60079-7. The ability to plug the Ex plugs into non-Ex sockets is guaranteed. In contrast, operation of the Ex sockets using non-Ex plugs is reliably prevented.











Zone	ATEX / IECEx					
	0	1	2	20	21	22
Installation in		x	x		x	x

WebCode 8579A

Plug and Socket Devices CES 63 A Series 8579

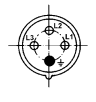

Selection Table

Version	No. of poles	Voltage [V]	Colour code	Frequency Hz	h	Metal adapter	Order number	Weight kg		
CES 63 A Switch socket  01679E00	 06556E00 4 P (3 P + 1)	200 ... 250	blue	50 and 60	9	--	8579/31-409	7.800		
		380 ... 415	red	50 and 60	6	--	8579/31-406	7.800		
		440 ... 460	red	60	11	--	8579/31-411	7.800		
		480 ... 500	black	50 and 60	7	--	8579/31-407	7.800		
		600 ... 690	black	50 and 60	5	--	8579/31-405	7.800		
		120 / 208 ... 144 / 250	blue	50 and 60	9	--	8579/31-509	7.800		
	 06555E00 5 P (3 P + N + 1)	200 / 346 ... 240 / 415	red	50 and 60	6	--	8579/31-506	7.800		
		277 / 480 ... 288 / 500	black	50 and 60	7	--	8579/31-507	7.800		
		250 / 440 ... 265 / 460	red	60	11	--	8579/31-511	7.800		
		347 / 600 ... 400 / 690	black	50 and 60	5	--	8579/31-505	7.800		
		For metal cable glands, versions with metal adapter								
		 06556E00 4 P (3 P + 1)	380 ... 415	red	50 and 60	6	M32 x 1.5	8579/31-406-S008	7.800	
	380 ... 415		red	50 and 60	6	M40 x 1.5	8579/31-406-S001	7.800		
	380 ... 415		red	50 and 60	6	M50 x 1.5	8579/31-406-S002	7.800		
	 06555E00 5 P (3 P + N + 1)	200 / 346 ... 240 / 415	red	50 and 60	6	M32 x 1.5	8579/31-506-S008	7.800		
		200 / 346 ... 240 / 415	red	50 and 60	6	M40 x 1.5	8579/31-506-S001	7.800		
		200 / 346 ... 240 / 415	red	50 and 60	6	M50 x 1.5	8579/31-506-S002	7.800		
	For metal cable glands, versions with metal adapter and earth connection*									
 06556E00 4 P (3 P + 1)	380 ... 415	red	50 and 60	6	M32 x 1.5	8579/31-406-S009	7.800			
	380 ... 415	red	50 and 60	6	M40 x 1.5	8579/31-406-S010	7.800			
	380 ... 415	red	50 and 60	6	M50 x 1.5	8579/31-406-S011	7.800			
 06555E00 5 P (3 P + N + 1)	200 / 346 ... 240 / 415	red	50 and 60	6	M32 x 1.5	8579/31-506-S009	7.800			
	200 / 346 ... 240 / 415	red	50 and 60	6	M40 x 1.5	8579/31-506-S010	7.800			
	200 / 346 ... 240 / 415	red	50 and 60	6	M50 x 1.5	8579/31-506-S011	7.800			
CES 63 A Plug  01679E00	 09191E00 4 P (3 P + 1)	200 ... 250	blue	50 and 60	9	--	8579/12-409	0.880		
		380 ... 415	red	50 and 60	6	--	8579/12-406	0.880		
		440 ... 460	red	60	11	--	8579/12-411	0.940		
		480 ... 500	black	50 and 60	7	--	8579/12-407	0.880		
		600 ... 690	black	50 and 60	5	--	8579/12-405	0.880		
		120 / 208 ... 144 / 250	blue	50 and 60	9	--	8579/12-509	0.940		
	 09196E00 5 P (3 P + N + 1)	200 / 346 ... 240 / 415	red	50 and 60	6	--	8579/12-506	0.940		
		250 / 440 ... 265 / 460	red	60	11	--	8579/12-511	0.940		
		277 / 480 ... 288 / 500	black	50 and 60	7	--	8579/12-507	0.940		
		347 / 600 ... 400 / 690	black	50 and 60	5	--	8579/12-505	0.940		
		Note								
		- Please order the additional auxiliary contacts separately, for the order number see chapter "Accessories and Spare Parts". - Switch sockets with Ex i auxiliary contacts available on request. * Earth connection outside on the enclosure 70 mm ²								

Plug and Socket Devices CES 63 A

Series 8579



Explosion Protection

Global (IECEx)

Gas and dust	IECEx PTB 06.0020 Ex d e IIC T6 Gb Ex d e IIC T5 Gb with intrinsically safe auxiliary contacts: Ex d e [ib Gb] IIC T6 Gb Ex d e [ib Gb] IIC T5 Gb Ex tb IIIC T60 °C ... T75 °C Db
--------------	---

Europe (ATEX)

Gas and dust	PTB 01 ATEX 1150 Ⓜ II 2 G Ex d e IIC T6 Gb Ⓜ II 2 G Ex d e IIC T5 Gb with intrinsically safe auxiliary contacts: Ⓜ II 2 G Ex d e [ib Gb] IIC T6 Gb Ⓜ II 2 G Ex d e [ib Gb] IIC T5 Gb Ⓜ II 2 D Ex tb IIIC T60 °C ... T75 °C Db
--------------	---

Certifications and certificates

Certificates	IECEx, ATEX, Brazil (INMETRO), China (China-Ex), India (PESO), Canada (CSA), Kazakhstan (TR), Korea (KCs), Russia (TR), Serbia (SRPS), Ukraine (TR), USA (FM), Belarus (TR)
--------------	---

Technical Data

Electrical data

Main contacts	
Rated operational voltage	max. 690 V
Rated insulation voltage	max. 690 V
Rated operational current	63 A
	≥ 100 Hz, 50 A
Switching capacity	according to IEC/EN 60947-3:
	AC-3
	DC-23
	DC-1
	690 V, 63 A
	220 V, 63 A ³⁾
	220 V, 63 A ³⁾
	18.5 kW, 220 / 230 / 240 V
	120 V, 63 A ²⁾
	120 V, 63 A ²⁾
	30 kW, 380 / 400 / 415 V
	60 V, 63 A ¹⁾
	60 V, 63 A ¹⁾
	37 kW, 500 V
	55 kW, 690 V
	¹⁾ 1 contact
	²⁾ 2 contacts connected in series
	³⁾ 3 contacts connected in series
Short-circuit protection	
With thermal protection	80 A gG
Without thermal protection	63 A gG
Auxiliary contacts	
Rated operational voltage	250 V AC for unequal potential 125 V DC 400 V AC, for equal potential of both contacts 500 V AC, when 1 NC + 1 NO and the same potential of both contacts is used
Rated operational current	max. 6 A
Short-circuit protection	6 A, tripping characteristic gG acc. to IEC/EN 60269-1

Ambient conditions

Ambient temperature	see Explosion Protection data - 45 °C on request (internal lubrication with silicone grease)
---------------------	---

Mechanical data

Service life	
electrical	20,000 operating cycles
Mechanical	100,000 operating cycles
Version	Socket 8579/31
Material	
Enclosure material	glass-fibre reinforced polyester
Switch handle	polyacetate, can be locked in 0- and I-position
Degree of protection	IP66 acc. to IEC/EN 60529
Version	Plug 8579/12
Degree of protection	IP66 acc. to IEC/EN 60529
Enclosure material	Polyamide

E3

Plug and Socket Devices CES 63 A

Series 8579



Technical Data

Mounting / Installation

Main contacts

Version

Connection cross-section

Tightening torque

Version

Connection cross-section

Tightening torque

Auxiliary contacts

Standard version

Possible auxiliary contacts

Connection cross-section

Tightening torque

Cable entries

Cable gland

Stopping plug

Socket 8579/31

max. 1 x 16 ... 50 mm², finely stranded / stranded; 2 x 16 mm²

6 Nm

Plug 8579/12

2,5 ... 16 mm²

max. 2 Nm

8080/1-1: 1 NC contact + 1 NO contact in left installation slot

NO contact ON delayed

NO contact OFF leading (> 20 ms before opening of the main contacts)

NC contacts synchronizing

max. 2 auxiliary contact blocks of type 8080/1 (slow-action contacts)

8080/1-1: 1 NC contact / 1 NO contact

NO contact ON delayed ¹⁾

NO contact OFF advanced (> 20 ms before opening of the main contacts) ¹⁾

NC contact synchronizing

8080/1-3: 2 NC contacts ²⁾

8080/1-4: 2 NO contacts ²⁾

¹⁾ only in the left installation slot, synchronising in the right installation slot

²⁾ synchronising in all installation slots

1.5 ... 2.5 mm² (AWG 16 ... 14) solid / finely stranded

0.4 Nm

1 x M50 x 1.5, cable dia. range 23 ... 35 mm; max. 2 x M40 x 1.5



1 x M25 x 1.5

Arrangement of contacts and terminal markings

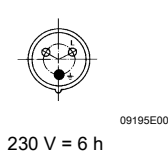
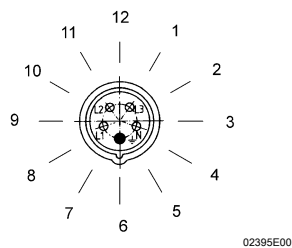
View from the front. The illustrations show the 6 h position.

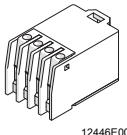
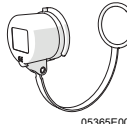
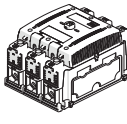

Accessories and Spare Parts



Designation	Figure	Description	Art. no.	Weight kg	
Auxiliary contact, Series 8080/1		1 NC contact + 1 NO contact (8080/1-1) ¹⁾	168351	0.026	
		2 NC contacts (8080/1-3) ²⁾	168356	0.026	
		2 NO contacts (8080/1-4) ²⁾	168353	0.026	
		The switching function of the auxiliary contact depends on the installation slot used. ¹⁾ Left: delayed (ON), leading (OFF); Right: synchronising ²⁾ Left and right: synchronising			
Protective cap		protects the plug pins from pollution	153261	0.100	
Switch insert		8544/1-31L	167239	2.200	
Plastic cable gland		8161/7-M25-1707 7 ... 17 mm ²	1 piece	229918	0.020
		8161/7-M50-3516 16 ... 35 mm ²	1 piece	229951	0.091

Plug and Socket Devices CES 63 A

Series 8579

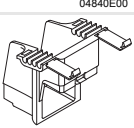

Accessories and Spare Parts

Designation	Figure	Description	Art. no.	Weight kg
Stopping plug		8290/3-M25 x 1,5	143524	0.007
Ex i cover		Ex i cover for auxiliary contacts for use in Ex i circuits	168855	0.008
Auxiliary contact key		for removing the mounted auxiliary contact	201909	0.035

E3

Dimensional Drawings (All Dimensions in mm) - Subject to Alterations

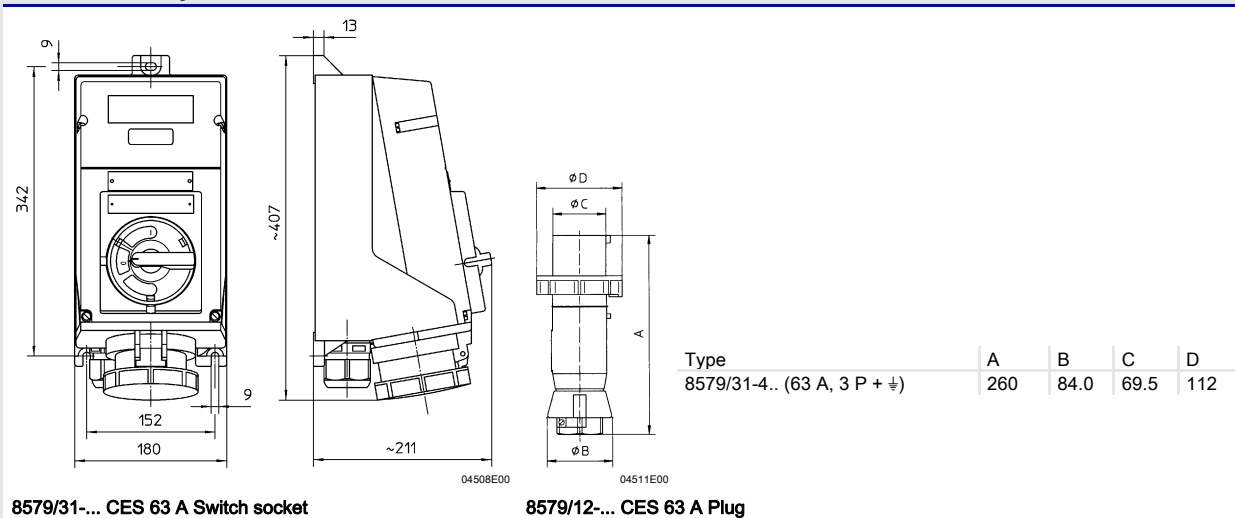

We reserve the right to make alterations to the technical data, dimensions, weights, designs and products available without notice. The illustrations cannot be considered binding.