

OIL MIST

CATALOG



Oil Mist Catalog

When mechanical performance is vital.....

Alemite Oil-Mist Lubrication Systems deliver!

What is Oil-Mist?

Oil-Mist is a cost justified, environmentally clean, safe, centralized lubrication system that continuously and efficiently atomizes oil into small particles and then conveys and delivers the correct amount of the pressurized lubricant to the surfaces requiring lubrication. Oil mist is the only lubrication system that can be used to continuously lubricate several different classes of operating or stand-by equipment in widely dispersed physical locations within the same facility using only one type of lubricant.

What can Oil-Mist do for you?

Alemite Oil-Mist Lubrication Systems deliver **controlled, continuous** lubrication to bearings, gears, chains, and other moving parts that are vital to the service life and productivity of plants and machinery. Alemite oil mist systems have been in operation for over 50 years. These systems are reliable, safe, green, and require minimum maintenance.

How It Works?

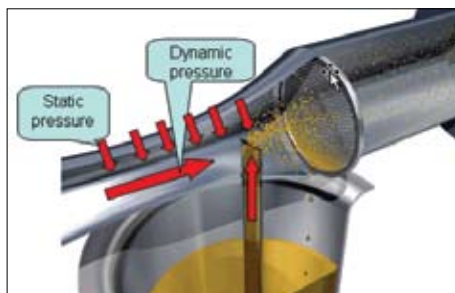

As compressed dry air passes through a venturi at very high speed; oil is introduced into the air stream by siphoning it from a reservoir. The resulting atomized oil particles average 1-5 microns. The suspended oil particles in the air resemble smoke and are dry enough to be transported at low pressure and velocity to distant machine elements.



Reclassifiers are used to introduce turbulence in the dry mist flow, causing the oil particles to coalesce and produce larger droplets which wet the interacting surfaces.

Carbon particles disassociate from these oil droplets when they meet the interacting surface leaving a solid carbon layer. Due to lower surface tension on the carbon layer than metallic surfaces, oil collects easier. The combination of a liquid lubrication layer and a continuously replenished solid lubrication layer leads to a powerful lubrication technique.

There are two techniques of applying oil mist lubrication to machine elements: Pure Mist and Purge Mist

Pure Mist

In the pure mist technique, the oil mist is supplied to a bearing housing which has been completely drained of oil.

Purge Mist

In the purge mist technique, the oil mist is conveyed into the vapor space above the oil level in a typical bearing housing.

Applications

Alemite has developed a broad line of equipment and application techniques to lubricate various machine elements from tiny, ultra-high speed parts for dentists' drills to huge gears and bearings of steel rolling mills. Oil mist is particularly suitable to lubricate anti friction bearings in virtually all categories of rotating machinery as well as chains, slides, ways, gears, and practically any surface needing lubrication.

Benefits

- ✓ Reduced maintenance requirements and downtime
 - Reduces bearing failures by up to 90%
 - Highly reliable systems, no sumps, pumps, or moving parts
- ✓ Lower operating temperature
 - Doesn't churn oil resulting in lower friction and temperature
- ✓ Reduced abrasive wear of surfaces
 - Fresh oil and air flushes system continuously
- ✓ Exclusion of corrosive gases and contaminants from operating surfaces
 - Slight positive pressure is maintained in the bearing housing
- ✓ Savings in energy and resources
 - Lowers friction energy loss
 - Lowers oil consumption by up to 40%
- ✓ Diversity of applications
 - Oil mist can be used on operating or stand by equipment, as well as in harsh environments



Alemite's oil mist system has an excellent track record in every industry and continent around the world. With modern demands for more complex machines running at higher speeds, and for greater reliability and economy, the list for Alemite Oil Mist Systems grows longer.

Oil Mist Catalog

■ 3920 Series Oil-Mist Generators

Provides lubrication for multiple lubrication points

1. Relief Value

Provides over-pressure protection

2. Clear 1 Pint Nylon Reservoir

Allows visual inspection of oil-level & mist generation

3. Refill Loader Fitting

Assures contamination-free oil replenishment

4. Patented Aluminum Mist Head

Provides corrosion protection for long trouble-free service

5. Oil Pick-up Screen

Prevents entrance of contaminants into mist generator



1. Float Switch

Provides signal when oil replenishment is required

2. Filter/Regulator

Adjusts mist generator performance; includes automatic water drain

3. Air Solenoid Valve

Allows automatic on-off operation when wired to machine driver or control

4. Steel Mounting Plate

Pre-piped assembly allows quick installation

CFM Nominal	Flow Range	Model No.	Mounting Plate	Oil Heater	Oil Level Switch	Filter/Regulator	Air Solenoid Value
1	0.3 - 1.4 CFM	3922-A	-	-	-	-	-
		3922-AC	Yes	-	-	Yes	120 VAC
		3922-B	-	-	120 VAC	-	-
		3922-BC	Yes	-	120 VAC	Yes	120 VAC
		3922-BD	Yes	-	220 VAC	Yes	220 VAC

■ 3940 Series Oil-Mist Generators

Provides lubrication for multiple lubrication points or machines

1. Relief Value

Provides over-pressure protection

2. Refill Loader Fitting

Assures contamination-free oil replenishment

3. Oil Level Sightglass

Provides visual inspection of oil level

4. Cast Aluminum 1-Gallon Reservoir

Baked polyester powder coated for decades of corrosion protection

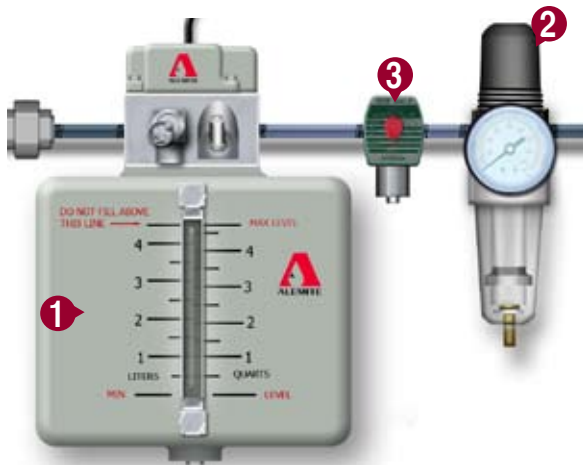

- 1. Float Switch** (inside the reservoir)
Provides signal when oil replenishment is required
- 2. Filter/Regulator**
Adjusts mist generator performance; includes automatic water drain
- 3. Air Solenoid Valve**
Allows automatic on-off operation when wired to machine driver or control.

CFM Nominal	Flow Range	Model No.	Mounting Plate	Oil Heater	Oil Level Switch	Filter/Regulator	Air Solenoid Value
1	0.3 - 1.4 CFM	3942-BC	Yes	-	120 VAC	Yes	120 VAC
		3942-BD	Yes	-	220 VAC	Yes	220 VAC
		3942-CB	Yes	120 VAC	120 VAC	Yes	-
		3942-CC	Yes	120 VAC	120 VAC	Yes	120 VAC
		3942-DD	Yes	220 VAC	220 VAC	Yes	220 VAC
2.3	0.8 - 3.1 CFM	3943-B	-	-	120 VAC	-	-
		3943-BC	Yes	-	120 VAC	Yes	120 VAC
		3943-BD	Yes	-	220 VAC	Yes	220 VAC
		3943-CB	Yes	120 VAC	120 VAC	Yes	-
		3943-CC	Yes	120 VAC	120 VAC	Yes	120 VAC
		3943-DD	Yes	220 VAC	220 VAC	Yes	220 VAC

Oil Mist Catalog

■ Modular Oil-Mist Generator

Provides customized lubrication for multiple lubrication points or machines

1. Filter/Regulator

Adjusts mist generator performance; includes automatic water drain.

2. Float Switch

Provides signal when oil replenishment is required

3. Sightglass

Provides visual inspection of oil level

4. Fabricated Steel Reservoirs

Available in 2 sizes with baked polyester powder coated enamel for decades of corrosion protection

5. Optional Thermo-Aire® Air Heater

Improves mist quality when using higher viscosity oils

6. Optional Auto Refill

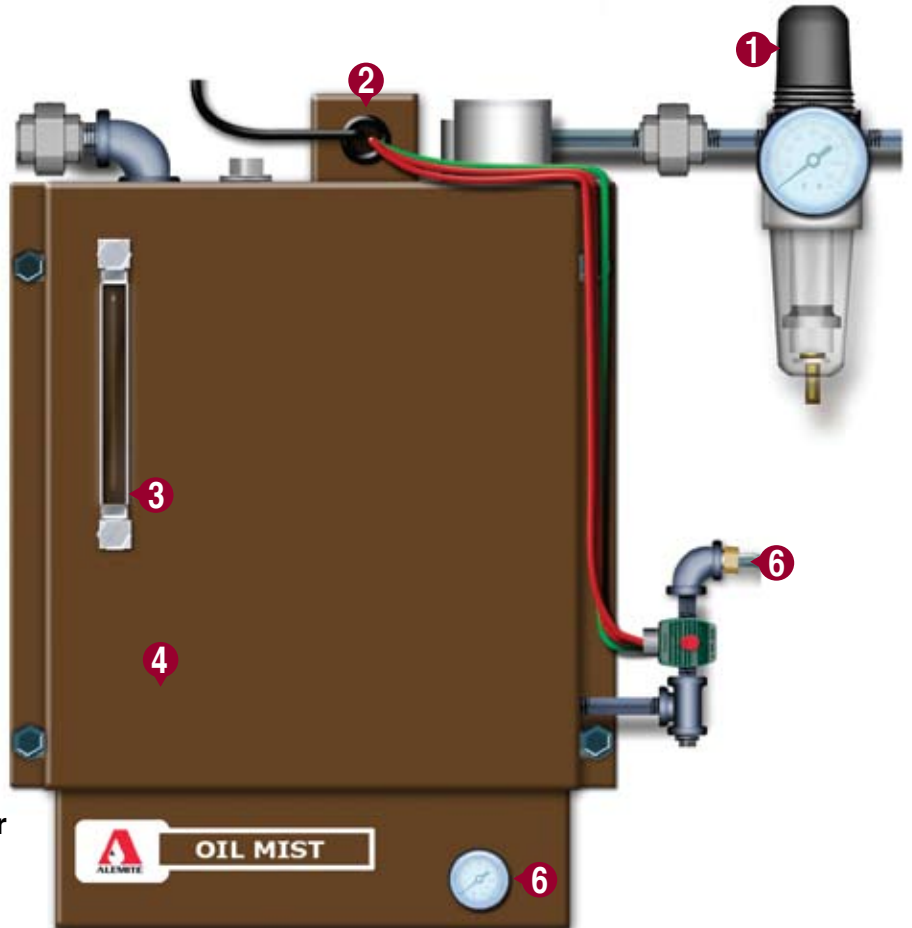

CFM Nominal	Flow Range	Reservoir Capacity	Model No.	Oil Heater	Oil Level Switch	Filter/Regulator	Air Solenoid Value
2.3	1.3 - 2.7 CFM	5-Quart	3705-B	120 VAC	120 VAC	Not Included See Accessories Section	
		3-Gallon	3705-C	120 VAC	120 VAC		
4.3	2.4 - 5.2 CFM	5-Quart	3706-B	120 VAC	120 VAC		
		3-Gallon	3706-C	120 VAC	120 VAC		
9.7	5.5 - 12.4 CFM	5-Quart	3707-B	120 VAC	120 VAC		
		3-Gallon	3707-C	120 VAC	120 VAC		
2.3	1.3 - 2.7 CFM	5-Quart	3705-E	220 VAC	220 VAC		
		3-Gallon	3705-F	220 VAC	220 VAC		
4.3	2.4 - 5.2 CFM	5-Quart	3706-E	220 VAC	220 VAC		
		3-Gallon	3706-F	220 VAC	220 VAC		
9.7	5.5 - 12.4 CFM	5-Quart	3707-E	220 VAC	220 VAC		
		3-Gallon	3707-F	220 VAC	220 VAC		
Thermo-Aire® Air Heater - 120 VAC - 220 VAC			383808-A4 383802-B4				

■ **Large Capacity Oil-Mist Generator**

Provides customized lubrication for multiple lubrication points or machines

1. Locking Hinged Cover
Prevents unauthorized tampering or adjustments

2. Mist Pressure Switch
May be used to energize a warning signal and/or stop machine

3. 3.6 Gallon Oil Reservoir

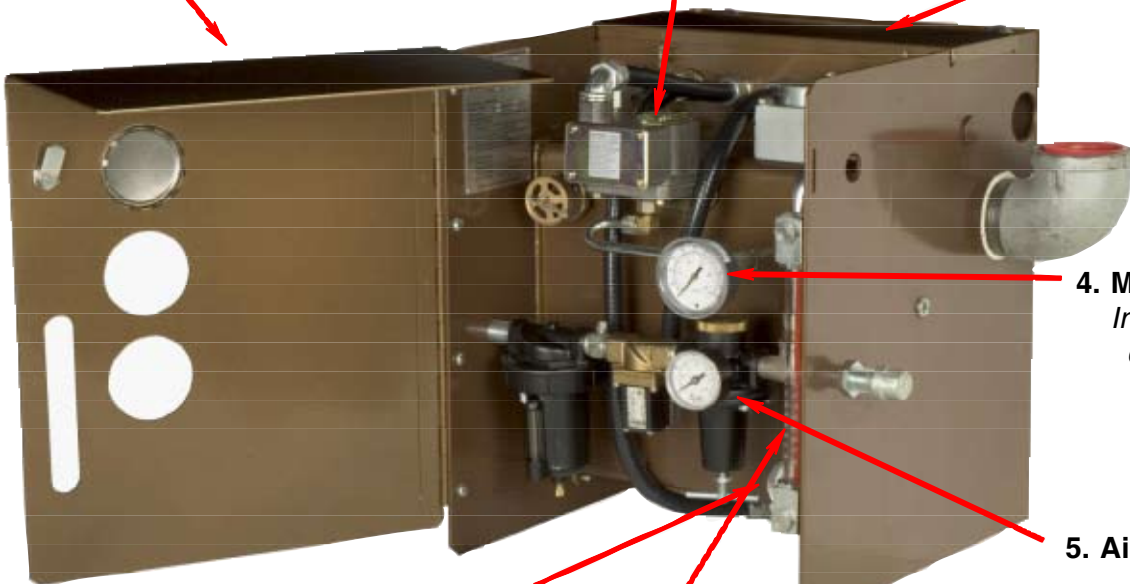

4. Mist Pressure Gauge
Indicates pressure in distribution header
Dual Scale
(0 - 100" H₂O)
(0-25Kpa)

5. Air Pressure Gauge
Dual Scale
(0 - 85 psi)
(0 - 6kg/cm²)

7. Oil Thermometer
Dual Scale
(0°F - 250°F)
(-20°C - 120°C)

6. Sightglass
Provides visual inspection of oil level

CFM Nominal	Flow Range	Model No.	Oil Heater	Oil Level Switch	Filter/Regulator	Air Solenoid Value
2.3	1.3- 2.7 CFM	3723-A6	115 VAC	115 VAC	Yes	115 VAC
4.3	2.4 - 5.2 CFM	3724-A6				
9.7	5.2 - 12.4 CFM	3725-A6				
13	7.5 - 16 CFM	3720-A6				
21	12 - 24 CFM	3721-A6				
41	23 - 45 CFM	3722-A6				
65	31 -73 CFM	3726-A6	230 VAC	230 VAC	Yes	230 VAC
13	7.5- 16 CFM	3720-B6				
21	12 - 24 CFM	3721-B6				
41	23- 45 CFM	3722-B6				
65	31 - 73 CFM	3726-B6				

All electrical components are 60/50 Hz

Oil Mist Catalog



1. Thermo-Aire® Air Heater

Improves mist quality when using higher viscosity oils

2. Air Thermometer

*Dual Scale
(50° - 300°F)
(10° - 150°C)*

3. Mist Pressure Gauge

*Indicates pressure in distribution header
Dual Scale
(0 - 100" H₂O)
(0-25Kpa)*

4. Air Pressure Gauge

*Dual Scale
(0 - 85 psi)
(0 - 6kg/cm²)*

5. 3.6 Gallon Oil Reservoir

6. Oil Thermometer

*Dual Scale
(0 - 250°F)
(-20° - 120°C)*

7. Sightglass

Provides visual inspection of oil level

CFM Nominal	Flow Range	Model No.	Oil Heater	Oil Level Switch	Filter/Regulator	Air Solenoid Value	Air Heater
13	5.2- 14 CFM	3730-RW6	115 VAC	115 VAC	Yes	115 VAC	230 VAC
21	10- 22 CFM	3731-RW6	115 VAC	115 VAC	Yes	115 VAC	230 VAC
41	20 - 45 CFM	3732-RW6	115 VAC	115 VAC	Yes	115 VAC	230 VAC
65	31 - 65 CFM	3736-RW6	115 VAC	115 VAC	Yes	115 VAC	230 VAC
13	5.2- 14 CFM	3730-BW6	230 VAC	230 VAC	Yes	230 VAC	230 VAC
21	10 - 22 CFM	3731-BW6	230 VAC	230 VAC	Yes	230 VAC	230 VAC
41	20- 45 CFM	3732-BW6	230 VAC	230 VAC	Yes	230 VAC	230 VAC
65	31 - 65 CFM	3736-BW6	230 VAC	230 VAC	Yes	230 VAC	230 VAC

All electrical components are 60/50 Hz

■ Mist Application Fittings

Mist fittings are metering orifices which deliver mist, with minimum condensation, to machine elements.



INLET 1/8 NPTF (FEMALE)		INLET 1/4 OD TUBE FTG
OUTLET 1/8 PTF* (m)	OUTLET 1/4 NPTF (m)	OUTLET 1/8 PTF* (m)
380791-2		381290-2
380791-4	381303-4	381290-4
380791-6	381303-6	381290-6
380791-10	381303-10	381290-10
380791-16	381303-16	381290-16

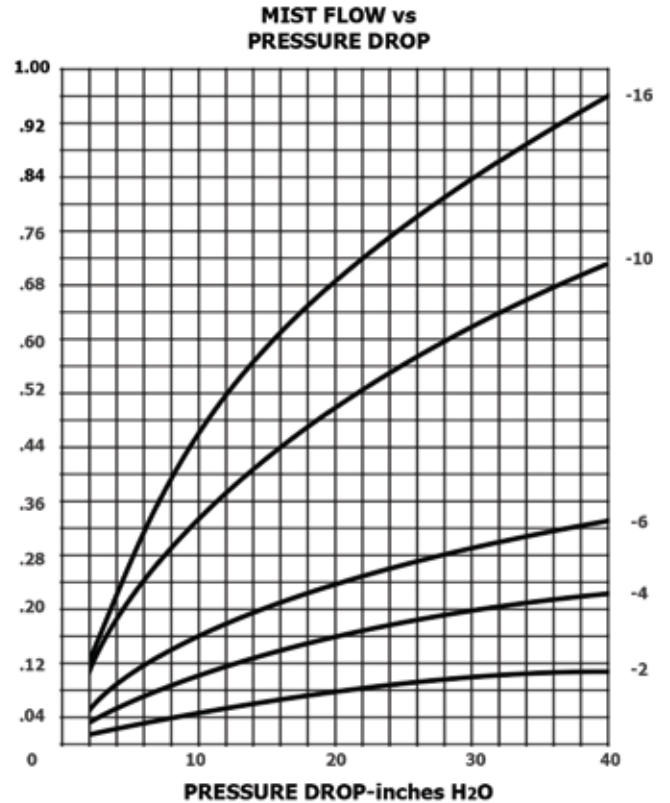

■ Condensing Application Fittings

Condensing fittings are metering orifices that convert mist to liquid oil within the fitting. The condensed oil flows by gravity to the machine element. The fittings are made of brass. Color is silver.



INLET 1/8 NPTF (f)	INLET 1/4 OD TUBE FTG
OUTLET 1/8 PTF* (m)	OUTLET 1/8 PTF* (m)
381281-06	
381281-1	381282-1
381281-2	381282-2
381281-3	381282-3
381281-4	381282-4
381281-5	381282-5

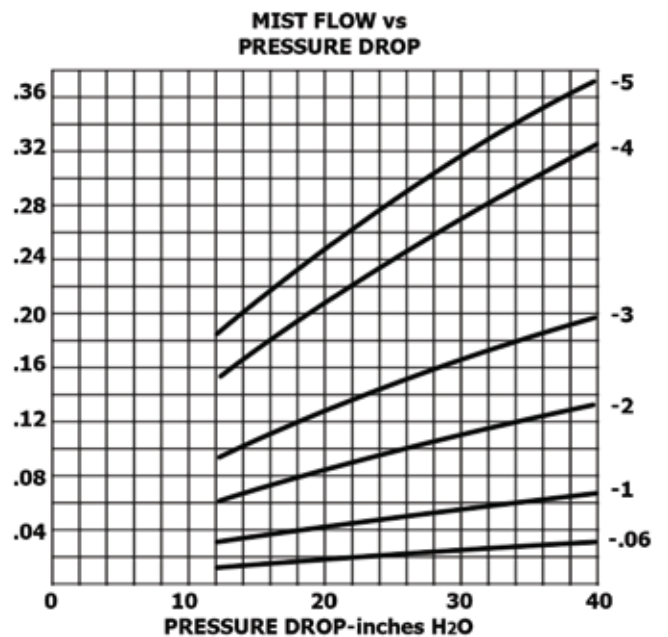

Oil Mist Catalog

■ Spray Application Fittings

Spray fittings are metering orifices which convert a high percentage of mist to an oil spray.



INLET 1/8 NPTF	INLET 1/4 inch OD Tube
OUTLET 1/8 NPTF	OUTLET 1/8 NPTF
381283-1	381288-1
381283-2	381288-2
381283-3	381288-3
381283-5	381288-5
381283-8	381288-8

PRESSURE DROP-inches H₂O

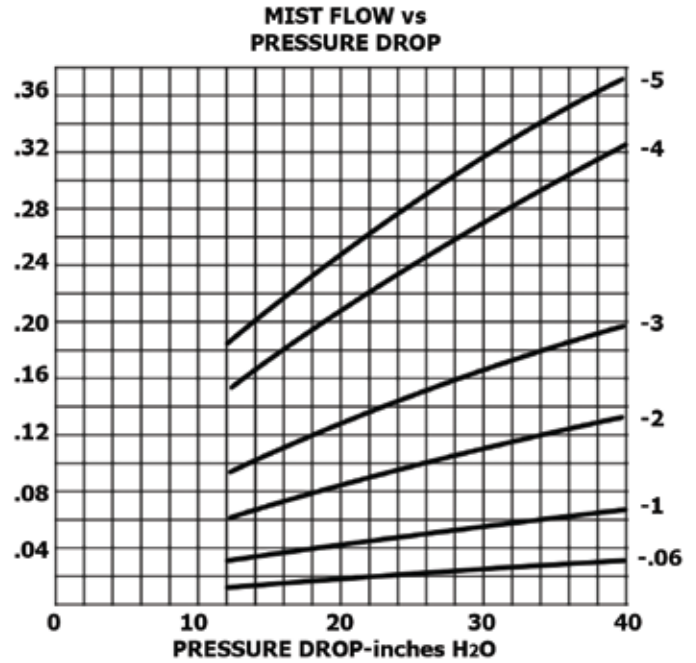

■ Spray Nozzle Application Fittings

Spray Nozzles contain one or more metering orifices that convert a high percentage of mist to an oil spray.



ONE END THREADED		BOTH ENDS THREADED		No. Of Orifices .067 DIA. 1.38LG.
1/2 NPTF (m)	3/4 NPTF (m)	1/4 NPTF (m)	1/2 PTF* (m)	
326370-1		383588-1	384280-1	1
326370-2		383588-2	384280-2	2
326370-3		383588-3	384280-3	3
326370-4		383588-4	384280-4	4
326370-5		383588-5	384280-5	5
326370-6		383588-6	384280-6	6
326370-7		383588-7	384280-7	7
326370-8			384280-8	8
326370-9			384280-9	9
326370-10	383617-10		384280-10	10
	383617-11			11
	383617-12			12
	383617-13			13
	383617-14			14

MIST FLOW vs PRESSURE DROP

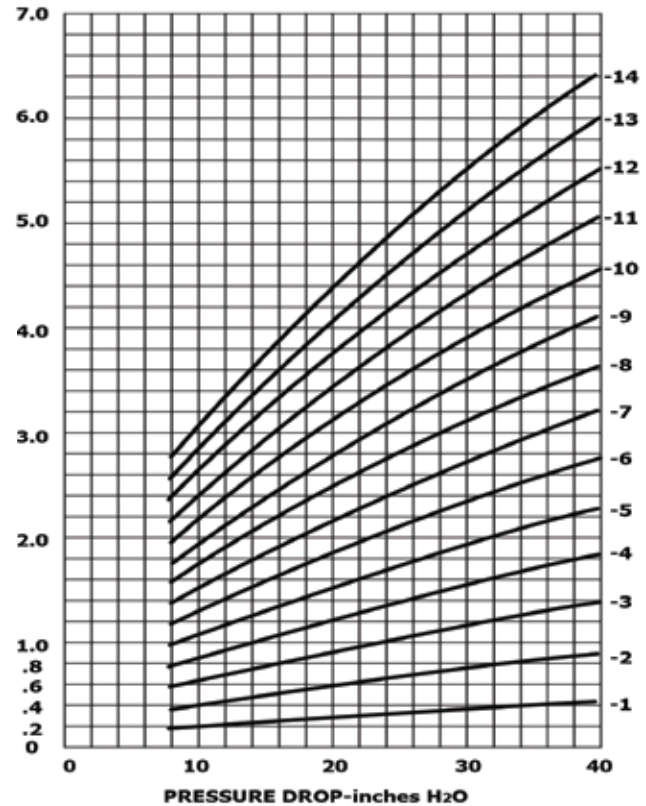

System Accessories

■ Filter/Regulator - P/N 7936

An air filter/regulator is required on all oil-mist systems. Incoming air must be clean and dry (instrument-quality). Adjustment of regulator will determine CFM and header pressure developed.

3900 Series Mist Generator Systems (Pint & Gallon units) come equipped with a filter/regulator as standard.

3700 Series Modular Mist Generator Systems do not have a filter/regulator and the 1/4" NPT unit shown (P/N 7936) must be added



■ Moisture Separator - P/N 5644-1

Extremely useful and recommended whenever instrument-quality air is not available. Assures clean, dry air for optimum atomization of oil. Removes up to 98% of entrained water. Water is automatically ejected through the bottom opening.

Built-in 40 micron porous bronze filter. Connections are 1/4" NPT.



■ Manifold Blocks - P/N 381173-2

Primarily used to provide remote mounting of mist fittings. 1-1/8" square aluminum blocks have 3/8" NPT(f) connections at both ends and 1/8" NPT(f) outlet ports spaced on 1" centers. Available in a variety of lengths and porting. Two mounting clamps with 11/32" holes are included.



■ Sightglass with "Snap" Drain Valve - P/N 385662-A1

Clear acrylic sightglass provides visual check of condensed oil. Brass "snap" valve permits quick draining and closes when released. Used on both manifold blocks and bearing housing drains. Equipped with 1/2" NPT(m) adapter.



Oil Mist Catalog

■ Alarm Annunciator - P/N 387275

Provides both visual and audible warning of system faults. Warns of low oil level (w/ optional level switch) and low/high mist pressure (w/ optional mist pressure switch).

Red and green lights signal system status. Dry contacts provided to energize a remote alarm (10 amps max.). 120VAC - 50/60 Hz.

Selector switch disables audible horn (adjustable volume) when desired.

Lamps, horn, and switch are mounted on front of NEMA 4X enclosure. Mounting bracket included.



■ Mist Pressure Switch - P/N 385033

When used with optional Alarm Annunciator (above), this safety switch responds to either a drop or rise in mist pressure and energizes alarm circuit. Factory set at 8" H₂O on falling pressure and 55" H₂O on rise. Total range is 0.8" H₂O to 83" H₂O.

Rated for 10 amp at 120 VAC. 1/4" NPT(f) pipe connection and 1/2" NPSM(f) conduit connection.



■ Mist Pressure Gauge - P/N 384889 -1/4" NPT, or P/N 382064 -1/8" NPT

0 - 100" H₂O gauges indicate pressure in mist distribution header.



■ Manual Refill Pump Assembly - P/N 7181-4

To overcome reservoir mist pressure, this pump (when used with special hose assembly with 40-micron filter and loader coupler) assures that only clean, filtered oil reaches reservoir. Pump has 3-gallon container and carrying handle.



■ Mist Collector

Holds up to 1/2 gallon of oil

P/N 387613

Holds up to 1 gallon of oil

P/N 387714



■ Mist Monitor - P/N 387596

FEATURES:

Fiber-optic sensor is designed to continuously monitor the established output of the oil mist generator

Included Items: Electronic Control Cabinet, Fiber-Optic Cables, Mist Manifold

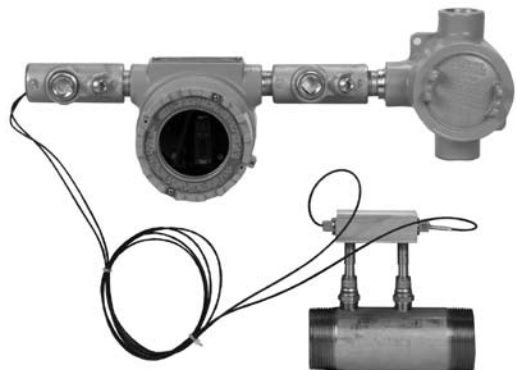

Oil Mist Catalog

■ 3940 Series Typical Installation Sketches

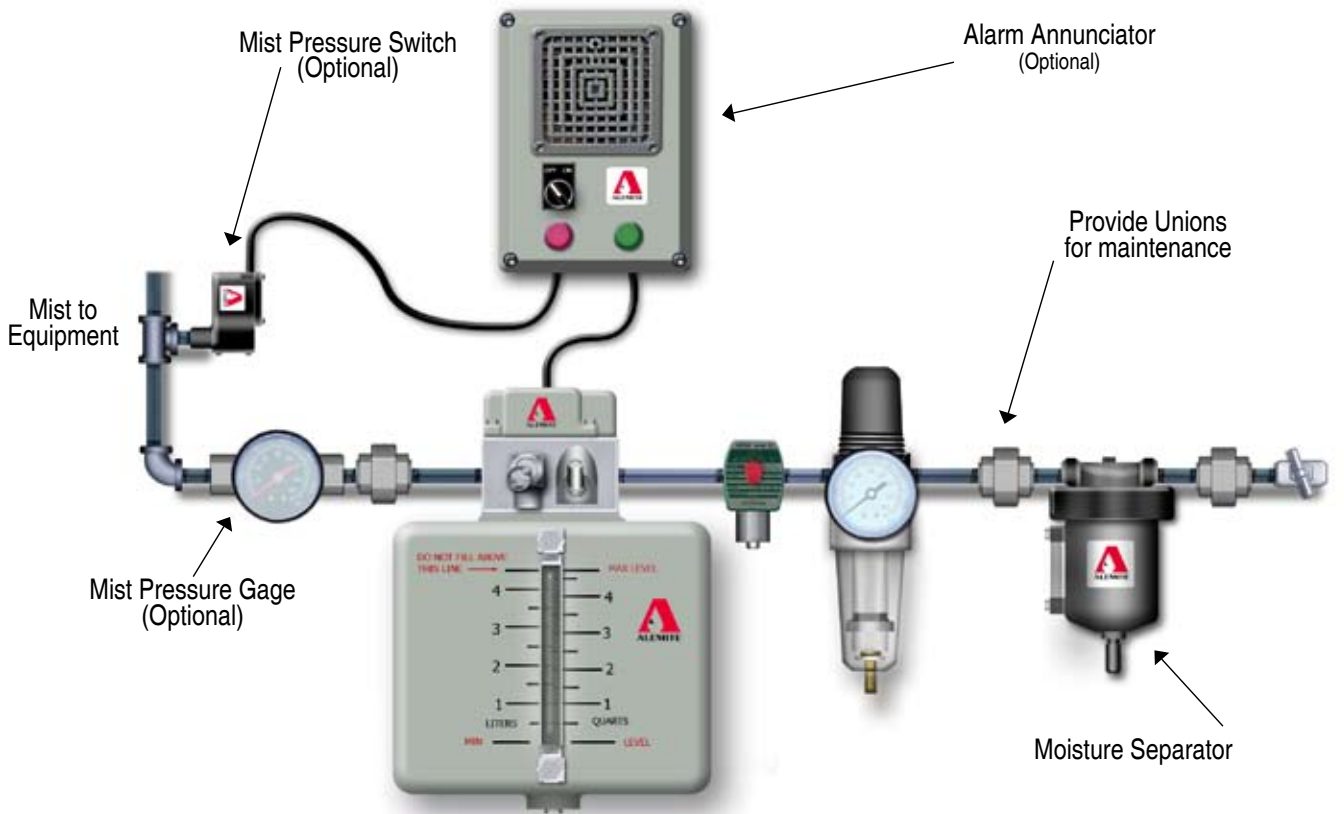

OIL MIST

CATALOG



1057 521 Corporate Center Dr. Suite 100
Fort Mill, SC 29707
Toll Free U.S.: 866-4-Alemite
Toll Free Canada: 800-267-8022
International: 803-802-0001
www.alemite.com

LIT156